

ENCORE

C E R A M I C S

2024 PRICE LIST



ENCORE CERAMICS . COM | P 541.955.8382
showroomsupport@encoreceramics.com | F 541.955.8342

Essentials Collection

ENCORE CERAMICS

Lower cost options produced at our normal lead time.

July 1, 2024 Wholesale Price List

Essentials Glazes – Gloss: Milk Matte: Frost Crackle: Bali, Beach, Bermuda, Brazil, Cirrus, Denim, Lagoon, Maize, Midnight, Moonlight, Pewter, Sandalwood, Sterling, Truffle

2x6 Field



2 1/8 x 6 3/8

11 pcs/sf

0.36 lbs/pc

Essentials Glazes

\$3.00 /pc

\$33.00 /sf

FT26E

3x6 Field



3 1/8 x 6 3/8

7.25 pcs/sf

0.56 lbs/pc

Essentials Glazes

\$3.95 /pc

\$28.64 /sf

FT36E

4x4 Field



4 1/4 x 4 1/4

8 pcs/sf

0.52 lbs/pc

Essentials Glazes

\$3.70 /pc

\$29.60 /sf

FT44E

1-3/8" Dots

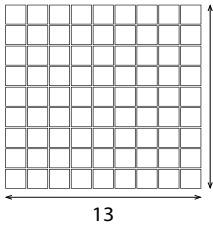

13 x 13

1.17 sf/sheet

5 lbs/sf

Essentials Glazes

\$43.00 /sf

MFDOE

13" *Solid "Essentials" colors only. For blends, use standard pricing.*

Devon

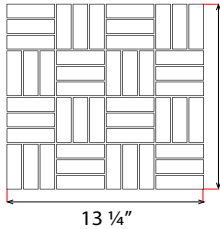

13 1/4 x 13 1/4

1.22 sf/sheet

5 lbs/sf

Essentials Glazes

\$40.00 /sf

MFDEVE

13 1/4" *Solid "Essentials" colors only. For blends, use standard pricing.*

Picket Small

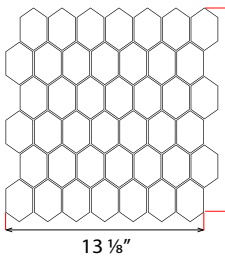

13 1/8 x 14 3/8

1.31 sf/sheet

5 lbs/sf

Essentials Glazes

\$46.00 /sf

MFPCSME

14 3/8" *Solid "Essentials" colors only. For blends, use standard pricing.*

Wave

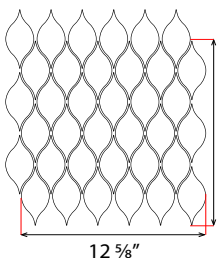

12 5/8 x 13 1/4

1.16 sf/sheet

5 lbs/sf

Essentials Glazes

\$45.00 /sf

MFWAVE

13 1/4" *Solid "Essentials" colors only. For blends, use standard pricing.*

2x2 Field



2 1/8 x 2 1/8	29.5 pcs/sf	0.15 lbs/pc	
Standard (G, M, C, S*)	\$1.70 /pc	\$50.15 /sf	FT22F
Jewel & Quartz (J, Q)	\$1.95 /pc	\$57.53 /sf	FT22J
Alloy (A*)	\$2.10 /pc	\$61.95 /sf	FT22A
Heritage (H)	\$2.10 /pc	\$61.95 /sf	FT22H
Precocious (P)	\$2.10 /pc	\$61.95 /sf	FT22P

see *Mosaics* for sheet options

2x2 Angle



2 1/8 x 2 1/8		0.15 lbs/pc	
Standard (G, M, C, S*)	\$7.15 /pc		A22

2x2 Bullnose



2 1/8 x 2 1/8		0.15 lbs/pc	
Standard (G, M, C, S*)	\$6.60 /pc		BN22

2x4 Field



2 1/8 x 4 1/4	14.5 pcs/sf	0.27 lbs/pc	
Standard (G, M, C, S*)	\$3.15 /pc	\$45.68 /sf	FT24F
Jewel & Quartz (J, Q)	\$3.70 /pc	\$53.65 /sf	FT24J
Alloy (A*)	\$3.95 /pc	\$57.28 /sf	FT24A
Heritage (H)	\$3.95 /pc	\$57.28 /sf	FT24H
Precocious (P)	\$3.95 /pc	\$57.28 /sf	FT24P
Wash (W)	\$3.95 /pc	\$57.28 /sf	FT24W

see *Mosaics* for sheet options

2x4 Bullnose

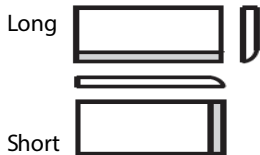

2 1/8 x 4 1/4		0.27 lbs/pc	
Standard (G, M, C, S*) Long	\$8.25 /pc		BNL24
Standard (G, M, C, S*) Short	\$8.25 /pc		BNS24

2x6 Field



2 1/8 x 6 3/8	11 pcs/sf	0.36 lbs/pc	
Standard (G, M, C, S*)	\$3.50 /pc	\$38.50 /sf	FT26F
Dimensional (G, M, S*)	\$4.00 /pc	\$44.00 /sf	FT26D
Jewel & Quartz (J, Q)	\$4.00 /pc	\$44.00 /sf	FT26J
Alloy (A*)	\$4.40 /pc	\$48.40 /sf	FT26A
Heritage (H)	\$4.40 /pc	\$48.40 /sf	FT26H
Precocious (P)	\$4.40 /pc	\$48.40 /sf	FT26P
Wash (W)	\$4.40 /pc	\$48.40 /sf	FT26W

2x6 Bullnose

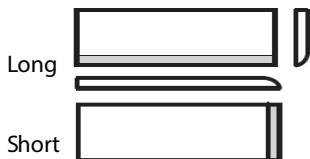



2 1/8 x 6 3/8		0.36 lbs/pc	
Standard (G, M, C, S*) Long	\$12.10 /pc		BNL26
Standard (G, M, C, S*) Short	\$12.10 /pc		BNS26

Glaze Codes:

(A) Alloy (C) Crackle (G) Gloss (H) Heritage (J) Jewel (M) Matte (P) Precocious (Q) Quartz (S) Sheer (W) Wash

* Alloys & Sheers are not recommended for pools or spas. Sheers are not recommended for floors.

2x8 Field	2 1/8 x 8 5/8	8 pcs/sf	0.58 lbs/pc	
	Standard (G, M, C, S*)	\$4.90 /pc	\$39.20 /sf	FT28F
	Alloy (A*)	\$6.15 /pc	\$49.20 /sf	FT28A
	Heritage (H)	\$6.15 /pc	\$49.20 /sf	FT28H
	Precocious (P)	\$6.15 /pc	\$49.20 /sf	FT28P

2x8 Bullnose	2 1/8 x 8 5/8		0.58 lbs/pc	
Long 	Standard (G, M, C, S*) Long	\$14.75 /pc		BNL28
	Standard (G, M, C, S*) Short	\$14.75 /pc		BNS28
Short 				

3x3 Field	3 1/8 x 3 1/8	15 pcs/sf	0.28 lbs/pc	
	Standard (G, M, C, S*)	\$3.15 /pc	\$47.25 /sf	FT33F
	Jewel & Quartz (J, Q)	\$3.70 /pc	\$55.50 /sf	FT33J
	Alloy (A*)	\$4.00 /pc	\$60.00 /sf	FT33A
	Heritage (H)	\$4.00 /pc	\$60.00 /sf	FT33H

3x3 Angle	3 1/8 x 3 1/8		0.28 lbs/pc	
	Standard (G, M, C, S*)	\$9.65 /pc		A33

3x3 Bullnose	3 1/8 x 3 1/8		0.28 lbs/pc	
	Standard (G, M, C, S*)	\$9.10 /pc		BN33

3x4 Field	3 1/8 x 4 1/4	11 pcs/sf	0.39 lbs/pc	
	Standard (G, M, C, S*)	\$4.05 /pc	\$44.55 /sf	FT34F
	Alloy (A*)	\$5.10 /pc	\$56.10 /sf	FT34A
	Heritage (H)	\$5.10 /pc	\$56.10 /sf	FT34H

3x6 Field	3 1/8 x 6 3/8	7.25 pcs/sf	0.56 lbs/pc	
	Standard (G, M, C, S*)	\$4.55 /pc	\$32.99 /sf	FT36F
	Alloy (A*)	\$5.70 /pc	\$41.33 /sf	FT36A
	Heritage (H)	\$5.70 /pc	\$41.33 /sf	FT36H
	Precocious (P)	\$5.70 /pc	\$41.33 /sf	FT36P
	Wash (W)	\$5.70 /pc	\$41.33 /sf	FT36W

3x6 Bevel Field	3 1/8 x 6 3/8	7.25 pcs/sf	0.74 lbs/pc	
	Standard (G, M, S*)	\$5.50 /pc	\$39.88 /sf	FT36B
	<i>No Crackle</i>			

Glaze Codes:

(A) Alloy (C) Crackle (G) Gloss (H) Heritage (J) Jewel (M) Matte (P) Precocious (Q) Quartz (S) Sheer (W) Wash

* Alloys & Sheers are not recommended for pools or spas. Sheers are not recommended for floors.

3x6 Bullnose



3 1/8 x 6 3/8

0.56 lbs/pc

Standard (G, M, C, S*) Long	\$12.10 /pc	BNL36
Standard (G, M, C, S*) Short	\$12.10 /pc	BNS36

3x8 Field



3 1/8 x 8 5/8

5.25 pcs/sf

0.72 lbs/pc

Standard (G, M, C, S*)	\$6.05 /pc	\$31.76 /sf	FT38F
Alloy (A*)	\$7.55 /pc	\$39.64 /sf	FT38A
Heritage (H)	\$7.55 /pc	\$39.64 /sf	FT38H
Precocious (P)	\$7.55 /pc	\$39.64 /sf	FT38P
Wash (W)	\$7.55 /pc	\$39.64 /sf	FT38W

3x8 Bullnose

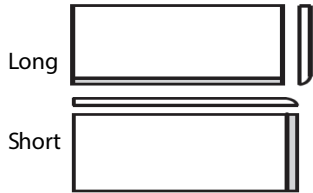

3 1/8 x 8 5/8

0.72 lbs/pc

Standard (G, M, C, S*) Long	\$14.75 /pc	BNL38
Standard (G, M, C, S*) Short	\$14.75 /pc	BNS38

4x4 Field



4 1/4 x 4 1/4

8 pcs/sf

0.52 lbs/pc

Standard (G, M, C, S*)	\$4.15 /pc	\$33.20 /sf	FT44F
Jewel & Quartz (J, Q)	\$4.80 /pc	\$38.40 /sf	FT44J
Alloy (A*)	\$5.20 /pc	\$41.60 /sf	FT44A
Heritage (H)	\$5.20 /pc	\$41.60 /sf	FT44H
Precocious (P)	\$5.20 /pc	\$41.60 /sf	FT44P
Wash (W)	\$5.20 /pc	\$41.60 /sf	FT44W

4x4 Angle



4 1/4 x 4 1/4

0.52 lbs/pc

Standard (G, M, C, S*)	\$11.00 /pc	A44
------------------------	-------------	-----

4x4 Bullnose



4 1/4 x 4 1/4

0.52 lbs/pc

Standard (G, M, C, S*)	\$10.45 /pc	BN44
------------------------	-------------	------

4x6 Field



4 1/4 x 6 3/8

5.5 pcs/sf







0.88 lbs/pc

Standard (G, M, C, S*)	\$6.45 /pc	\$35.48 /sf	FT46F
Alloy (A*)	\$8.05 /pc	\$44.28 /sf	FT46A
Heritage (H)	\$8.05 /pc	\$44.28 /sf	FT46H

Glaze Codes:

(A) Alloy (C) Crackle (G) Gloss (H) Heritage (J) Jewel (M) Matte (P) Precocious (Q) Quartz (S) Sheer (W) Wash

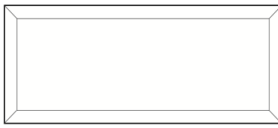
* Alloys & Sheers are not recommended for pools or spas. Sheers are not recommended for floors.

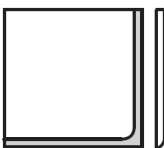
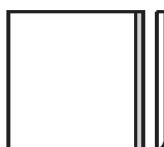
4x8 Field		4 1/4 x 8 5/8	4 pcs/sf	1.06 lbs/pc	
		Standard (G, M, C, S*)	\$10.20 /pc	\$40.80 /sf	FT48F
		Alloy (A*)	\$12.75 /pc	\$51.00 /sf	FT48A
		Heritage (H)	\$12.75 /pc	\$51.00 /sf	FT48H
		Precocious (P)	\$12.75 /pc	\$51.00 /sf	FT48P
		Wash (W)	\$12.75 /pc	\$51.00 /sf	FT48W
4x8 Bullnose		4 1/4 x 8 5/8		1.06 lbs/pc	
Long		Standard (G, M, C, S*) Long	\$16.70 /pc		BNL48
		Standard (G, M, C, S*) Short	\$16.70 /pc		BNS48
Short					
4x10 Field		4 1/4 x 10 3/8	3.25 pcs/sf	1.26 lbs/pc	
		Standard (G, M, C, S*)	\$13.20 /pc	\$42.90 /sf	FT410F
		Alloy (A*)	\$16.50 /pc	\$53.63 /sf	FT410A
		Heritage (H)	\$16.50 /pc	\$53.63 /sf	FT410H
4x10 Bevel Field		4 1/4 x 10 3/8	3.25 pcs/sf	1.85 lbs/pc	
		Standard (G, M, S*)	\$15.85 /pc	\$51.51 /sf	FT410B <i>No Crackle</i>
		<i>No Crackle</i>			
6x6 Field		6 3/8 x 6 3/8	3.6 pcs/sf	1.17 lbs/pc	
		Standard (G, M, C, S*)	\$9.10 /pc	\$32.76 /sf	FT66F
		Alloy (A*)	\$11.40 /pc	\$41.04 /sf	FT66A
		Heritage (H)	\$11.40 /pc	\$41.04 /sf	FT66H
		Wash (W)	\$11.40 /pc	\$41.04 /sf	FT66W
6x6 Angle		6 3/8 x 6 3/8		1.17 lbs/pc	
		Standard (G, M, C, S*)	\$17.90 /pc		A66
6x6 Bullnose		6 3/8 x 6 3/8		1.17 lbs/pc	
		Standard (G, M, C, S*)	\$17.35 /pc		BN66

Glaze Codes:

(A) Alloy (C) Crackle (G) Gloss (H) Heritage (J) Jewel (M) Matte (P) Precocious (Q) Quartz (S) Sheer (W) Wash

* Alloys & Sheers are not recommended for pools or spas. Sheers are not recommended for floors.

6x8 Field



6 3/8 x 8 5/8	2.6 pcs/sf	1.61 lbs/pc	
Standard (G, M, C, S*)	\$16.50 /pc	\$42.90 /sf	FT68F
Heritage (H)	\$19.70 /pc	\$51.22 /sf	FT68H

Chevron 4x10

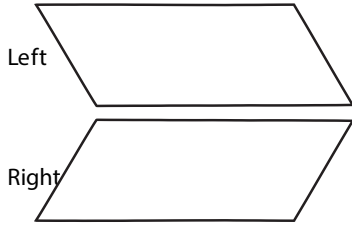

4 x 10	3.6 pcs/sf	1.2 lbs/pc	
Standard (G, M, C, S*) Left	\$13.75 /pc	\$49.50 /sf	FT410CHLF
Standard (G, M, C, S*) Right	\$13.75 /pc	\$49.50 /sf	FT410CHRF

Dunham

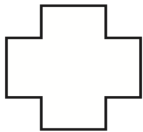

4 7/8 x 4 7/8	7.25 pcs/sf	0.6 lbs/pc	
Standard (G, M, C, S*)	\$6.35 /pc	\$46.04 /sf	FTDUNF
Alloy (A*)	\$7.55 /pc	\$54.74 /sf	FTDUNA
Heritage (H)	\$7.55 /pc	\$54.74 /sf	FTDUNH

Finish Edge 1x6



1 x 6 3/8		0.2 lbs/pc	
Standard (G, M, C, S*)	\$13.20 /pc		BN16FIN
Precocious (P)	\$16.50 /pc		BN16FINP

Hamlet



4 3/4 x 7 1/2	7.14 pcs/sf	0.95 lbs/pc	
Standard (G, M, C, S*)	\$6.50 /pc	\$46.41 /sf	FTHAMF
Alloy (A*)	\$8.15 /pc	\$58.19 /sf	FTHAMA
Heritage (H)	\$8.15 /pc	\$58.19 /sf	FTHAMH

COMING LATE SUMMER 2024

Hexagon 3.5"

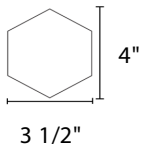

	12.9 pcs/sf	0.32 lbs/pc	
Standard (G, M, C, S*)	\$3.05 /pc	\$39.35 /sf	FT35HEXF
Jewel & Quartz (J, Q)	\$3.50 /pc	\$45.15 /sf	FT35HEXJ
Alloy (A*)	\$3.80 /pc	\$49.02 /sf	FT35HEXA
Heritage (H)	\$3.80 /pc	\$49.02 /sf	FT35HEXH

see [Mosaics](#) for mosaic options

Hexagon 6"

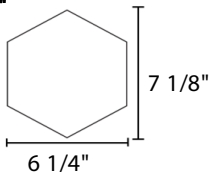

	4.5 pcs/sf	0.95 lbs/pc	
Standard (G, M, C, S*)	\$8.00 /pc	\$36.00 /sf	FT66HEXF
Alloy (A*)	\$10.00 /pc	\$45.00 /sf	FT66HEXA

Hexagon Long 4x8

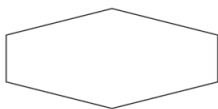







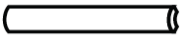

4 x 8	6 pcs/sf	0.7 lbs/pc	
Standard (G, M, C, S*)	\$6.45 /pc	\$38.70 /sf	FT48HEXF
Alloy (A*)	\$8.05 /pc	\$48.30 /sf	FT48HEXA
Heritage (H)	\$8.05 /pc	\$48.30 /sf	FT48HEXH
Precocious (P)	\$8.05 /pc	\$48.30 /sf	FT48HEXP

Glaze Codes:

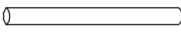
(A) Alloy (C) Crackle (G) Gloss (H) Heritage (J) Jewel (M) Matte (P) Precocious (Q) Quartz (S) Sheer (W) Wash

* Alloys & Sheers are not recommended for pools or spas. Sheers are not recommended for floors.

Picket Medium 	3 x 6 3/4	8 pcs/sf	0.64 lbs/pc	
	Standard (G, M, C, S*)	\$5.25 /pc	\$42.00 /sf	FTPICMEDF
	Precocious (P)	\$6.55 /pc	\$52.40 /sf	FTPICMEDP
Picket Medium Bevel 	3 x 6 3/4	8 pcs/sf	0.75 lbs/pc	
	Standard (G, M, S*)	\$6.30 /pc	\$50.40 /sf	FTPICMEDB
	<i>No Crackle</i>			
Quarter Round 1x6 	1 1/8 x 6 3/8		0.2 lbs/pc	
	Standard (G, M, C, S*)	\$12.60 /pc		QR16
	Heritage (H)	\$15.75 /pc		QR16H
	Precocious (P)	\$15.75 /pc		QR16P
Quarter Round Beak 	1 x 1		0.1 lbs/pc	
	Standard (G, M, C, S*)	\$13.15 /pc		B11
	Heritage (H)	\$16.45 /pc		B11H
	Precocious (P)	\$16.45 /pc		B11P
Quarter Round Mini 	1/4 x 6 1/2		0.06 lbs/pc	
	Standard (G, M, C, S*)	\$11.55 /pc		QRM126
	Alloy (A*)	\$14.45 /pc		QRM126A
	Heritage (H)	\$14.45 /pc		QRM126H
	Precocious (P)	\$14.45 /pc		QRM126P
Rhombus 3x7 Field Tile 	3 5/8 x 7	11 pcs/sf	0.36 lbs/pc	
	Standard (G, M, C, S*)	\$4.00 /pc	\$44.00 /sf	FT37F
	Heritage (H)	\$5.00 /pc	\$55.00 /sf	FT37H
Siren Field Tile 	6 3/4 x 6	6.5 pcs/sf	1.17 lbs/pc	
	Standard (G, M, C, S*)	\$7.70 /pc	\$50.05 /sf	FTSIRF
	Heritage (H)	\$9.65 /pc	\$62.73 /sf	FTSIRH
Sutton field tile 	6 3/8 x 6 3/8	7.4 pcs/sf	0.8 lbs/pc	
	Standard (G, M, C, S*)	\$5.95 /pc	\$44.03 /sf	DFSUTF
	Alloy (A*)	\$7.45 /pc	\$55.13 /sf	DFSUTA
	Heritage (H)	\$7.45 /pc	\$55.13 /sf	DFSUTH

Glaze Codes:

(A) Alloy (C) Crackle (G) Gloss (H) Heritage (J) Jewel (M) Matte (P) Precocious (Q) Quartz (S) Sheer (W) Wash

* Alloys & Sheers are not recommended for pools or spas. Sheers are not recommended for floors.

1/2 x 3 Broken Joint

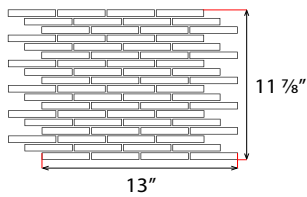

1.07 sf/sheet

Standard (G, M, C, S*)
 Jewel & Quartz (J, Q)
 Alloy (A*)

5 lbs/sf

\$57.00 /sf MF123BJ
 \$65.55 /sf MF123BJJ
 \$71.25 /sf MF123BJA

1/2 x 3 Herringbone

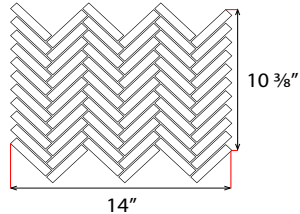

1.01 sf/sheet

Standard (G, M, C, S*)
 Jewel & Quartz (J, Q)
 Alloy (A*)

5 lbs/sf

\$55.00 /sf MF123HE
 \$63.25 /sf MF123HEJ
 \$68.75 /sf MF123HEA

1/2 x 6 Broken Joint

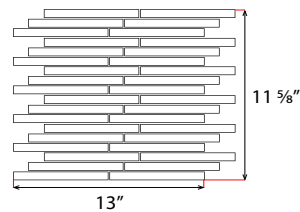

1.05 sf/sheet

Standard (G, M, C, S*)
 Dimensional (G, M, S*) *No Crackle*
 Jewel & Quartz (J, Q)
 Heritage (H)

6 lbs/sf

\$54.60 /sf MF126BJ
 \$62.80 /sf MF126BJD
 \$62.80 /sf MF126BJJ
 \$68.25 /sf MF126BJH

1/2 x 6 Herringbone

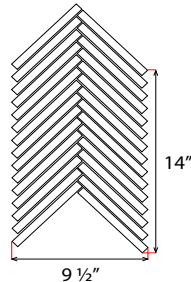

0.92 sf/sheet

Standard (G, M, C, S*)
 Dimensional (G, M, S*) *No Crackle*
 Jewel & Quartz (J, Q)
 Heritage (H)

5 lbs/sf

\$52.50 /sf MF126HE
 \$60.70 /sf MF126HED
 \$60.70 /sf MF126HEJ
 \$65.65 /sf MF126HEH

1 x 1 Mosaic

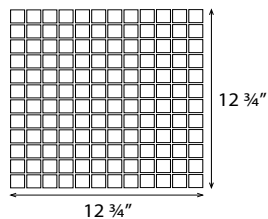

1.13 sf/sheet

Standard (G, M, C, S*)
 Dimensional (G, M, S*) *No Crackle*
 Jewel & Quartz (J, Q)
 Stone Basic *Up to 25%*
 Stone Prem *Calacatta/Thassos Up to 25%*

5.6 lbs/sf

\$58.30 /sf MF11
 \$67.05 /sf MF11D
 \$67.05 /sf MF11J
 \$81.60 /sf MF11S
 \$87.45 /sf MF11SP

1-3/8" Dots

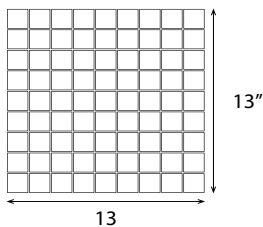

1.17 sf/sheet

Standard (G, M, C, S*)
 Jewel & Quartz (J, Q)
 Alloy (A*)
 Heritage (H)
 Precocious (P)
 Stone Basic *Up to 25%*
 Stone Prem *Calacatta/Thassos Up to 25%*

5 lbs/sf

\$49.50 /sf MFDOT
 \$56.95 /sf MFDOTJ
 \$61.90 /sf MFDOTA
 \$61.90 /sf MFDOTH
 \$61.90 /sf MFDOTP
 \$69.30 /sf MFDOTS
 \$74.25 /sf MFDOTSP

Glaze Codes:

(A) Alloy (C) Crackle (G) Gloss (H) Heritage (J) Jewel (M) Matte (P) Precocious (Q) Quartz (S) Sheer (W) Wash
 * Alloys & Sheers are not recommended for pools or spas. Sheers are not recommended for floors.

1 x 3 Brick

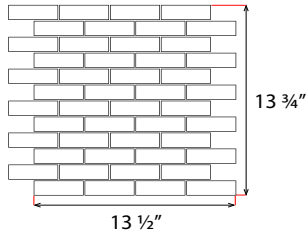

1.29 sf/sheet

5 lbs/sf

Standard (G, M, C, S*)	\$46.20 /sf	MF13BR
Dimensional (G, M, S*) <i>No Crackle</i>	\$53.15 /sf	MF13BRD
Jewel & Quartz (J, Q)	\$53.15 /sf	MF13BRJ
Alloy (A*)	\$57.75 /sf	MF13BRA
Heritage (H)	\$57.75 /sf	MF13BRH

1 x 3 Herringbone

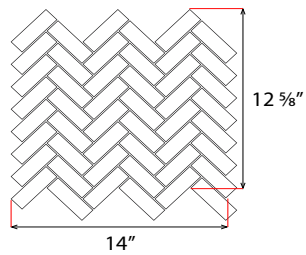

1.23 sf/sheet

5 lbs/sf

Standard (G, M, C, S*)	\$48.50 /sf	MF13HE
Dimensional (G, M, S*) <i>No Crackle</i>	\$55.80 /sf	MF13HED
Jewel & Quartz (J, Q)	\$60.65 /sf	MF13HEJ
Alloy (A*)	\$60.65 /sf	MF13HEA
Heritage (H)	\$60.65 /sf	MF13HEH

1 x 3 Stacked

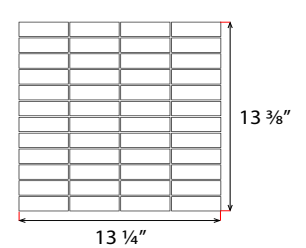

1.23 sf/sheet

5 lbs/sf

Standard (G, M, C, S*)	\$48.50 /sf	MF13ST
Dimensional (G, M, S*) <i>No Crackle</i>	\$55.80 /sf	MF13STD
Jewel & Quartz (J, Q)	\$60.65 /sf	MF13STJ
Alloy (A*)	\$60.65 /sf	MF13STA
Heritage (H)	\$60.65 /sf	MF13STH

1 x 6 Broken Joint

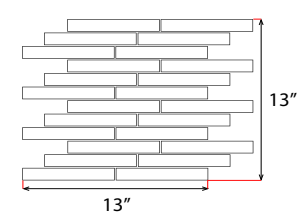

1.17 sf/sheet

6 lbs/sf

Standard (G, M, C, S*)	\$44.10 /sf	MF16BJ
Jewel & Quartz (J, Q)	\$50.70 /sf	MF16BJJ
Alloy (A*)	\$55.15 /sf	MF16BJA
Heritage (H)	\$55.15 /sf	MF16BJH

1 x 6 Stacked

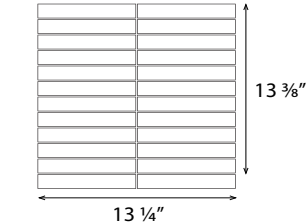

1.23 sf/sheet

6 lbs/sf

Standard (G, M, C, S*)	\$42.00 /sf	MF16ST
Jewel & Quartz (J, Q)	\$48.30 /sf	MF16STJ
Alloy (A*)	\$52.50 /sf	MF16STA
Heritage (H)	\$52.50 /sf	MF16STH

2 x 2 Mosaic

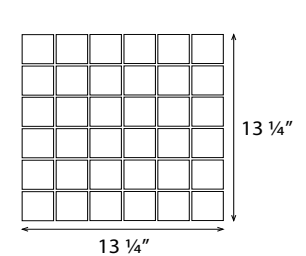

1.22 sf/sheet

5.5 lbs/sf

Standard (G, M, C, S*)	\$52.50 /sf	MF22
Dimensional (G, M, S*) <i>No Crackle</i>	\$60.40 /sf	MF22D
Jewel & Quartz (J, Q)	\$60.40 /sf	MF22J
Alloy (A*)	\$65.65 /sf	MF22A
Heritage (H)	\$65.65 /sf	MF22H
Precocious (P)	\$65.65 /sf	MF22P
Wash (W) <i>Up to 25%. No Mirage.</i>	\$65.65 /sf	MF22W

Glaze Codes:

(A) Alloy **(C)** Crackle **(G)** Gloss **(H)** Heritage **(J)** Jewel **(M)** Matte **(P)** Precocious **(Q)** Quartz **(S)** Sheer **(W)** Wash

* Alloys & Sheers are not recommended for pools or spas. Sheers are not recommended for floors.

2 x 4 Brick

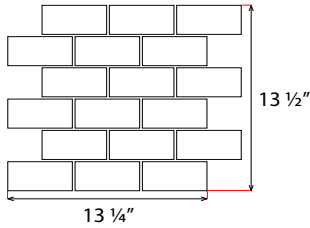

1.24 sf/sheet

Standard (G, M, C, S*)
Jewel & Quartz (J, Q)
Alloy (A*)
Heritage (H)
Precocious (P)
Wash (W)

3.7 lbs/sf

\$49.35 /sf	MF24BR
\$56.75 /sf	MF24BRJ
\$61.70 /sf	MF24BRA
\$61.70 /sf	MF24BRH
\$61.70 /sf	MF24BRP
\$61.70 /sf	MF24BRW

2 x 4 Herringbone

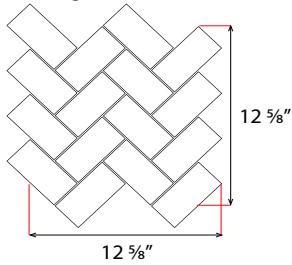

1.11 sf/sheet

Standard (G, M, C, S*)
Jewel & Quartz (J, Q)
Alloy (A*)
Heritage (H)
Precocious (P)
Wash (W)

3.7 lbs/sf

\$48.30 /sf	MF24HE
\$55.55 /sf	MF24HEJ
\$60.40 /sf	MF24HEA
\$60.40 /sf	MF24HEH
\$60.40 /sf	MF24HEP
\$60.40 /sf	MF24HEW

Arabesque

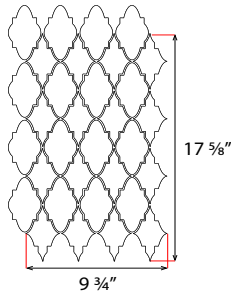

1.24 sf/sheet

Standard (G, M, C, S*)
Dimensional (G, M, H, S*)
Jewel & Quartz (J, Q)
Alloy (A*)
Heritage (H)
Wash (W) <i>Up to 50%. No Mirage.</i>
Stone Basic <i>Up to 50%</i>
Stone Prem <i>Calacatta/Thassos Up to 50%</i>

5.5 lbs/sf

\$51.70 /sf	MFARB
\$59.45 /sf	MFARBD
\$59.45 /sf	MFARBJ
\$64.65 /sf	MFARBA
\$64.65 /sf	MFARBH
\$64.65 /sf	MFARBW
\$72.40 /sf	MFARBS
\$77.55 /sf	MFARBSP

[Complete Specification Form](#)

Arabesque Border Large

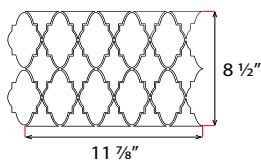

1.02 lf/sheet

Standard (G, M, C, S*)
Dimensional (G, M, H, S*) <i>No halves</i>
Jewel & Quartz (J, Q)
Alloy (A*)
Heritage (H)
Wash (W) <i>No Mirage</i>

4 lbs/lf

\$43.05 /lf	MBARBLG
\$49.50 /lf	MBARBLGD
\$49.50 /lf	MBARBLGJ
\$53.80 /lf	MBARBLGA
\$53.80 /lf	MBARBLGH
\$53.80 /lf	MBARBLGW

[Complete Specification Form](#)

Arabesque Border Small Part 1

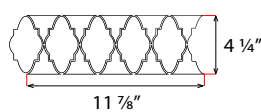

1.02 lf/sheet

Standard (G, M, C, S*)
Jewel & Quartz (J, Q)
Alloy (A*)
Heritage (H)
Wash (W) <i>No Mirage</i>

2.3 lbs/lf

\$24.15 /lf	MBARBSM1
\$27.80 /lf	MBARBSM1J
\$30.20 /lf	MBARBSM1A
\$30.20 /lf	MBARBSM1H
\$30.20 /lf	MBARBSM1W

[Complete Specification Form](#)

Arabesque Border Small Part 2

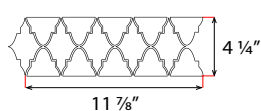

1.02 lf/sheet

Standard (G, M, C, S*)
Jewel & Quartz (J, Q)
Alloy (A*)
Heritage (H)
Wash (W) <i>No Mirage</i>

2.3 lbs/lf

\$24.15 /lf	MBARBSM2
\$27.80 /lf	MBARBSM2J
\$30.20 /lf	MBARBSM2A
\$30.20 /lf	MBARBSM2H
\$30.20 /lf	MBARBSM2W

[Complete Specification Form](#)

Glaze Codes:

(A) Alloy **(C)** Crackle **(G)** Gloss **(H)** Heritage **(J)** Jewel **(M)** Matte **(P)** Precocious **(Q)** Quartz **(S)** Sheer **(W)** Wash
 * Alloys & Sheers are not recommended for pools or spas. Sheers are not recommended for floors.

Arcadia

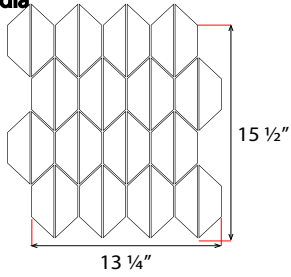

1.43 sf/sheet

4.6 lbs/sf

Standard (G, M, C, S*)	\$48.40 /sf	MFARC
Jewel & Quartz (J, Q)	\$55.65 /sf	MFARCJ
Alloy (A*)	\$60.50 /sf	MFARCA
Heritage (H)	\$60.50 /sf	MFARCH
Wash (W)	\$60.50 /sf	MFARCW

Atherton

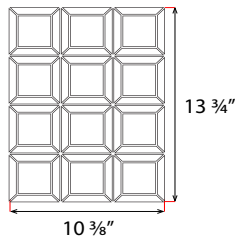

0.99 sf/sheet

5 lbs/sf

Standard (G, M, C, S*)	\$56.70 /sf	MFATH
Jewel & Quartz (J, Q) <i>2x2 only</i>	\$65.20 /sf	MFATHJ
Alloy (A*) <i>2x2 only</i>	\$70.90 /sf	MFATHA
Heritage (H) <i>2x2 only</i>	\$70.90 /sf	MFATHH
Precocious (P) <i>2x2 only</i>	\$70.90 /sf	MFATHP
Wash (W) <i>2x2 only. No Mirage.</i>	\$70.90 /sf	MFATHW

[Complete Specification Form](#)

Bahia

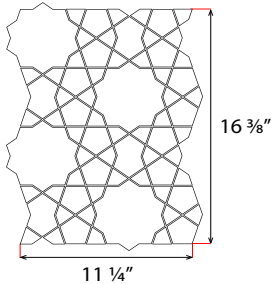

1.28 sf/sheet

5 lbs/sf

Standard (G, M, C, S*)	\$69.30 /sf	MFBAH
Alloy (A*)	\$86.65 /sf	MFBAHA
Heritage (H) <i>No Part A</i>	\$86.65 /sf	MFBAHH
Wash (W) <i>Part A Only</i>	\$86.65 /sf	MFBAHW

[Complete Specification Form](#)

Belvedere

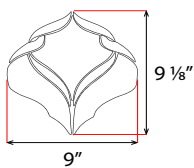

0.36 sf/sheet

4 lbs/sf

Standard (G, M, C, S*)	\$60.90 /sf	MBBEL
Dimensional (G, M, C, S*) <i>Ribbons only</i>	\$70.00 /sf	MBBELD
Jewel & Quartz (J, Q)	\$70.00 /sf	MBBELJ
Alloy (A*)	\$76.15 /sf	MBBELA

[Complete Specification Form](#)

Biltmore

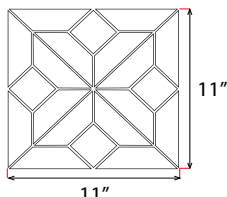

0.84 sf/sheet

4.6 lbs/sf

Standard (G, M, C, S*)	\$49.30 /sf	MBBIL
Jewel & Quartz (J, Q)	\$56.70 /sf	MBBILJ
Alloy (A*)	\$61.65 /sf	MBBILA
Heritage (H)	\$61.65 /sf	MBBILH
Precocious (P) <i>2x2 only</i>	\$61.65 /sf	MBBILP
Wash (W)	\$61.65 /sf	MBBILW

[Complete Specification Form](#)

[Complete Specification Form](#)

Campbell

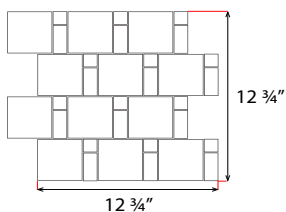

1.13 sf/sheet

4.7 lbs/sf

Standard (G, M, C, S*)	\$49.35 /sf	MFCAM
Circle Mini 1x1 (G, M, C, S*, J, Q)	\$56.75 /sf	MFCAMC
Dimensional 1x1 (G, M, S*) <i>No Crackle</i>	\$56.75 /sf	MFCAMD
Jewel & Quartz (J, Q) <i>No 1x2</i>	\$56.75 /sf	MFCAMJ
Heritage (H)	\$61.70 /sf	MFCAMH

[Complete Specification Form](#)

Glaze Codes:

(A) Alloy **(C)** Crackle **(G)** Gloss **(H)** Heritage **(J)** Jewel **(M)** Matte **(P)** Precocious **(Q)** Quartz **(S)** Sheer **(W)** Wash

* Alloys & Sheers are not recommended for pools or spas. Sheers are not recommended for floors.

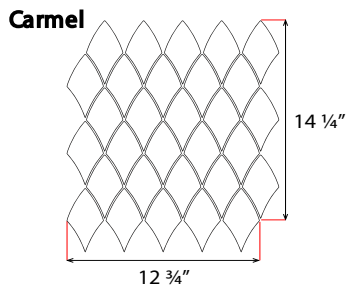

1.26 sf/sheet	5 lbs/sf	
Standard (G, M, C, S*)	\$49.35 /sf	MFCRM
Jewel & Quartz (J, Q)	\$56.75 /sf	MFCRMJ
Alloy (A*)	\$61.70 /sf	MFCRMA
Heritage (H)	\$61.70 /sf	MFCRMH
Precocious (P) <i>Up to 25%</i>	\$61.70 /sf	MFCRMP
Wash (W) <i>Up to 25%</i>	\$61.70 /sf	MFCRMW

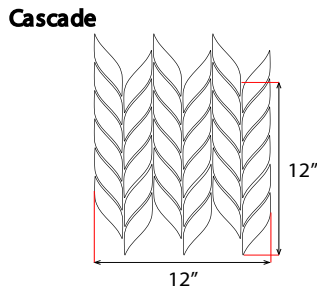

1.0 sf/sheet	4.5 lbs/sf	
Standard (G, M, C, S*)	\$50.40 /sf	MFCAS
Jewel & Quartz (J, Q)	\$57.95 /sf	MFCASJ
Alloy (A*)	\$63.00 /sf	MFCASA
Heritage (H)	\$63.00 /sf	MFCASH
Stone Basic <i>Up to 25%</i>	\$70.55 /sf	MFCASS
Stone Prem Calacatta/Thassos <i>Up to 25%</i>	\$75.60 /sf	MFCASSP

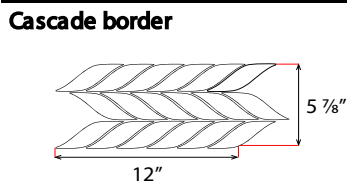

1.0 lf/sheet	2.25 lbs/sf	
Standard (G, M, C, S*)	\$24.15 /lf	MBCAS
Jewel & Quartz (J, Q)	\$27.80 /lf	MBCASJ
Alloy (A*)	\$30.20 /lf	MBCASA
Heritage (H)	\$30.20 /lf	MBCASH

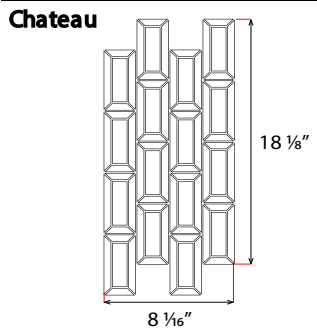

1.01 sf/sheet	4.6 lbs/sf	
Standard (G, M, C, S*)	\$64.65 /sf	MFCHA
Jewel & Quartz (J, Q) <i>1x3 only</i>	\$74.35 /sf	MFCHAJ
Heritage (H) <i>1x3 only</i>	\$80.80 /sf	MFCHAH

[Complete Specification Form](#)

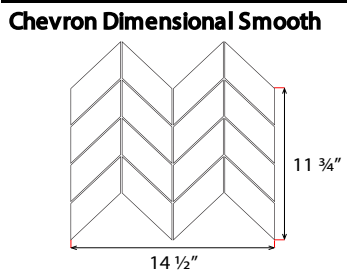

1.18 sf/sheet	5.5 lbs/sf	
Dimensional (G, M)	\$58.80 /sf	MFCHDS

Gloss & Matte only

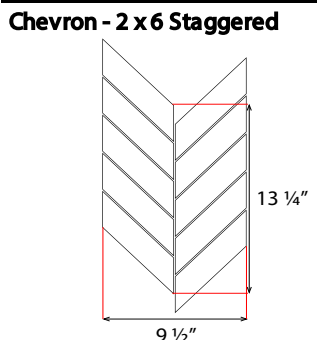

0.87 sf/sheet	5 lbs/sf	
Standard (G, M, C, S*)	\$46.20 /sf	MFCHSTLG
Jewel & Quartz (J, Q)	\$53.15 /sf	MFCHSTLGJ
Alloy (A*)	\$57.75 /sf	MFCHSTLGA
Wash (W) <i>Heron only</i>	\$57.75 /sf	MFCHSTLGW

Glaze Codes:

(A) Alloy **(C)** Crackle **(G)** Gloss **(H)** Heritage **(J)** Jewel **(M)** Matte **(P)** Precocious **(Q)** Quartz **(S)** Sheer **(W)** Wash
 * Alloys & Sheers are not recommended for pools or spas. Sheers are not recommended for floors.

Chevron 3"

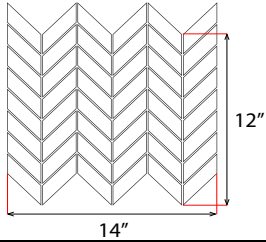

1.17 sf/sheet

4 lbs/sf

Standard (G, M, C, S*)

\$57.75 /sf

MFCH3

Circles - Medium

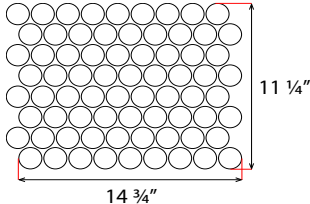

1.15 sf/sheet

4.5 lbs/sf

Standard (G, M, C, S*)

\$53.55 /sf

MFCIRMED

Jewel & Quartz (J, Q)

\$61.60 /sf

MFCIRMEDJ

Alloy (A*)

\$66.95 /sf

MFCIRMEDA

Heritage (H)

\$66.95 /sf

MFCIRMEDH

Precocious (P)

\$66.95 /sf

MFCIRMEDP

Circles - Mini

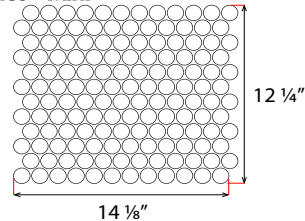

1.2 sf/sheet

4.4 lbs/sf

Standard (G, M, C, S*)

\$68.25 /sf

MFCIRMIN

Jewel & Quartz (J, Q)

\$78.50 /sf

MFCIRMINJ

Alloy (A*)

\$85.30 /sf

MFCIRMINA

Heritage (H)

\$85.30 /sf

MFCIRMINH

Precocious (P)

\$85.30 /sf

MFCIRMINP

Circles - Mini Border

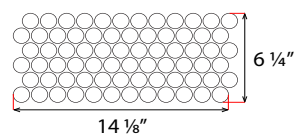

1.18 lf/sheet

2.2 lbs/lf

Standard (G, M, C, S*)

\$29.40 /lf

MBCIRMIN

Jewel & Quartz (J, Q)

\$33.80 /lf

MBCIRMINJ

Alloy (A*)

\$36.75 /lf

MBCIRMINA

Heritage (H)

\$36.75 /lf

MBCIRMINH

Precocious (P)

\$36.75 /lf

MBCIRMINP

Circles - Mixed

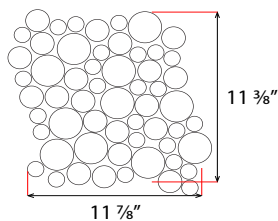

0.94 sf/sheet

4.3 lbs/sf

Standard (G, M, C, S*)

\$45.90 /sf

MFCIRMIX

Jewel & Quartz (J, Q)

\$52.80 /sf

MFCIRMIXJ

Alloy (A*)

\$57.40 /sf

MFCIRMIXA

Heritage (H)

\$57.40 /sf

MFCIRMIXH

Precocious (P)

\$57.40 /sf

MFCIRMIXP

Circles - Mixed Border

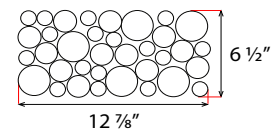

1.07 lf/sheet

2.15 lbs/lf

Standard (G, M, C, S*)

\$25.80 /lf

MBCIRMIX

Jewel & Quartz (J, Q)

\$29.70 /lf

MBCIRMIXJ

Alloy (A*)

\$32.25 /lf

MBCIRMIXA

Heritage (H)

\$32.25 /lf

MBCIRMIXH

Precocious (P)

\$32.25 /lf

MBCIRMIXP

Cordoba

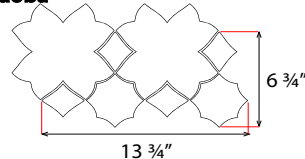

0.64 sf/sheet

3.5 lbs/sf

Standard (G, M, C, S*)

\$44.10 /sf

MFCOD

Alloy (A*)

\$55.15 /sf

MFCODA

Heritage (H)

\$55.15 /sf

MFCODH

[Complete Specification Form](#)

Glaze Codes:

(A) Alloy **(C)** Crackle **(G)** Gloss **(H)** Heritage **(J)** Jewel **(M)** Matte **(P)** Precocious **(Q)** Quartz **(S)** Sheer **(W)** Wash

* Alloys & Sheers are not recommended for pools or spas. Sheers are not recommended for floors.

Cross & Dot

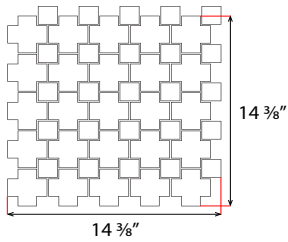

1.44 sf/sheet

Standard (G, M, C, S*)	\$43.25 /sf	MFCRDT
Jewel & Quartz (J, Q) <i>Dots only</i>	\$49.75 /sf	MFCRDTJ
Alloy (A*)	\$54.05 /sf	MFCRDTA

5.5 lbs/sf

\$43.25 /sf	MFCRDT
\$49.75 /sf	MFCRDTJ
\$54.05 /sf	MFCRDTA

Only available mesh-mounted

Damask

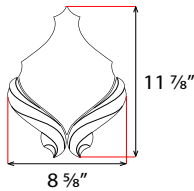

0.4 sf/sheet

Standard (G, M, C, S*)	\$58.00 /sf	MFDAMD
Alloy (A*)	\$72.50 /sf	MFDAMDA

5 lbs/sf

\$58.00 /sf	MFDAMD
\$72.50 /sf	MFDAMDA

Scroll is offered dimensional only.

COMING LATE SUMMER 2024

Devon

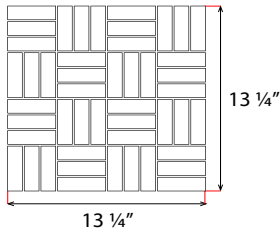

1.22 sf/sheet

Standard (G, M, C, S*)	\$47.90 /sf	MFDEV
Jewel & Quartz (J, Q)	\$55.10 /sf	MFDEVJ
Alloy (A*)	\$72.40 /sf	MFDEVA
Heritage (H)	\$72.40 /sf	MFDEVH
Precocious (P)	\$72.40 /sf	MFDEVP

5 lbs/sf

\$47.90 /sf	MFDEV
\$55.10 /sf	MFDEVJ
\$72.40 /sf	MFDEVA
\$72.40 /sf	MFDEVH
\$72.40 /sf	MFDEVP

Eliot Mixed Broken Joint

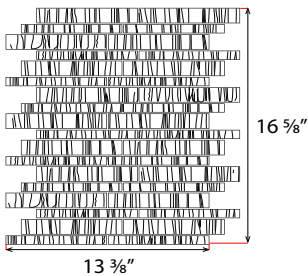

1.54 sf/sheet

Standard (G, M, C, S*)	\$53.55 /sf	MFELIMXBJ
Alloy (A*)	\$66.95 /sf	MFELIMXBJA
Heritage (H)	\$66.95 /sf	MFELIMXBJH

5.5 lbs/sf

\$53.55 /sf	MFELIMXBJ
\$66.95 /sf	MFELIMXBJA
\$66.95 /sf	MFELIMXBJH

Eliot Mixed Stacked

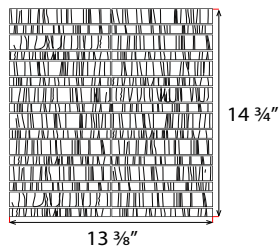

1.37 sf/sheet

Standard (G, M, C, S*)	\$53.55 /sf	MFELIMXST
Alloy (A*)	\$66.95 /sf	MFELIMXSTA
Heritage (H)	\$66.95 /sf	MFELIMXSTH

5.5 lbs/sf

\$53.55 /sf	MFELIMXST
\$66.95 /sf	MFELIMXSTA
\$66.95 /sf	MFELIMXSTH

Exeter

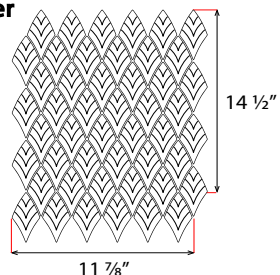

1.2 sf/sheet

Standard (G, M, C, S*)	\$50.00 /sf	MFEXE
Alloy (A*)	\$62.50 /sf	MFEXEA
Heritage (H)	\$62.50 /sf	MFEXEH

4.9 lbs/sf

\$50.00 /sf	MFEXE
\$62.50 /sf	MFEXEA
\$62.50 /sf	MFEXEH

Glaze Codes:

(A) Alloy **(C)** Crackle **(G)** Gloss **(H)** Heritage **(J)** Jewel **(M)** Matte **(P)** Precocious **(Q)** Quartz **(S)** Sheer **(W)** Wash

* Alloys & Sheers are not recommended for pools or spas. Sheers are not recommended for floors.

Feather

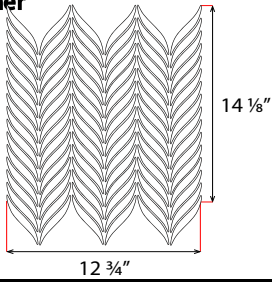

1.25 sf/sheet

5 lbs/sf

Standard (G, M, C, S*)	\$73.50 /sf	MFFEA
Jewel & Quartz (J, Q)	\$84.55 /sf	MFFEAJ
Stone Basic <i>Up to 25%</i>	\$102.90 /sf	MFFEAS
Stone Prem <i>Calacatta/Thassos Up to 25%</i>	\$110.25 /sf	MFFEASP

[Complete Specification Form](#)

Fez

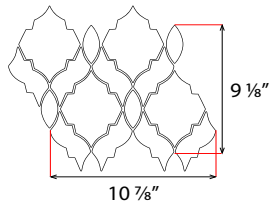

0.69 sf/sheet

4.5 lbs/sf

Standard (G, M, C, S*)	\$49.35 /sf	MFFEZ
Alloy (A*)	\$61.70 /sf	MFFEZA
Heritage (H)	\$61.70 /sf	MFFEZH

[Complete Specification Form](#)

Flame

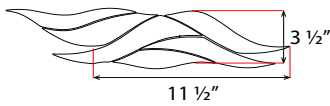

0.28 sf/sheet

4 lbs/sf

Standard (G, M, C, S*)	\$79.80 /sf	MFFLA
Jewel & Quartz (J, Q)	\$91.80 /sf	MFFLAJ

Flight

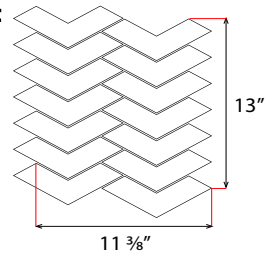

1.03 sf/sheet

5 lbs/sf

Standard (G, M, C, S*)	\$47.25 /sf	MFFLI
Alloy (A*)	\$59.05 /sf	MFFLIA

Granada

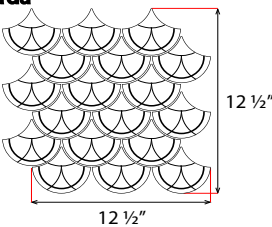

1.02 sf/sheet

3.8 lbs/sf

Jewel & Quartz (J, Q)	\$50.40 /sf	MFGRAJ
-----------------------	-------------	--------

[Complete Specification Form](#)

Granada Large Border

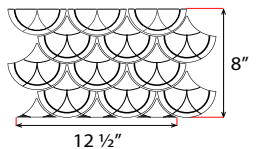

1.04 lf/sheet

3 lbs/lf

Jewel & Quartz (J, Q)	\$34.65 /lf	MBGRALGJ
-----------------------	-------------	----------

[Complete Specification Form](#)

Granada Small Border

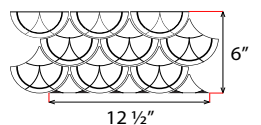

1.04 lf/sheet

2.8 lbs/lf

Jewel & Quartz (J, Q)	\$26.25 /lf	MBGRASMJ
-----------------------	-------------	----------

[Complete Specification Form](#)

Glaze Codes:

(A) Alloy **(C)** Crackle **(G)** Gloss **(H)** Heritage **(J)** Jewel **(M)** Matte **(P)** Precocious **(Q)** Quartz **(S)** Sheer **(W)** Wash
 * Alloys & Sheers are not recommended for pools or spas. Sheers are not recommended for floors.

Halves & Ones

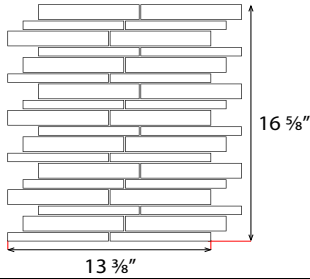

1.54 sf/sheet

6 lbs/sf

Standard (G, M, C, S*)	\$49.35 /sf	MFH&OBJ
Alloy (A*)	\$61.70 /sf	MFH&OBA
Heritage (H)	\$61.70 /sf	MFH&OBJH

Halves & Ones Stacked

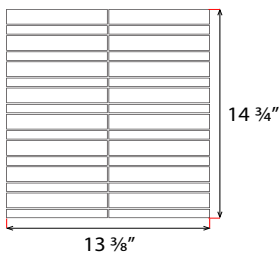

1.37 sf/sheet

5 lbs/sf

Standard (G, M, C, S*)	\$49.35 /sf	MFH&OST
Alloy (A*)	\$61.70 /sf	MFH&OSTA
Heritage (H)	\$61.70 /sf	MFH&OSTH

Herringbone Mixed 1/2x6 & 2x6

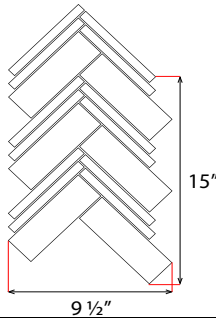

0.99 sf/sheet

4.5 lbs/sf

Standard (G, M, C, S*)	\$40.75 /sf	MFMIXHE
Alloy (A*)	\$50.95 /sf	MFMIXHEA
Heritage (H)	\$50.95 /sf	MFMIXHEH
Stone Basic <i>1/2 x 6 only</i>	\$57.05 /sf	MFMIXHES
Stone Prem <i>Calacatta/Thassos 1/2 x 6 only</i>	\$61.15 /sf	MFMIXHESP

Hexagon 1"

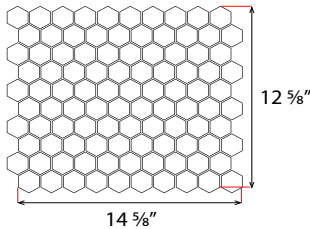

1.28 sf/sheet

4.9 lbs/sf

Standard (G, M, C, S*)	\$62.70 /sf	MFHEX
Jewel & Quartz (J, Q)	\$72.10 /sf	MFHEXJ
Alloy (A*)	\$78.40 /sf	MFHEXA
Heritage (H)	\$78.40 /sf	MFHEXH
Stone Basic <i>Up to 25%</i>	\$87.80 /sf	MFHEXS
Stone Prem <i>Calacatta/Thassos Up to 25%</i>	\$94.05 /sf	MFHEXSP

Hexagon 2"

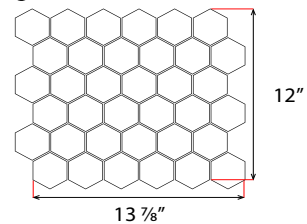

1.16 sf/sheet

5 lbs/sf

Standard (G, M, C, S*)	\$45.15 /sf	MFHEX2
Jewel & Quartz (J, Q)	\$51.95 /sf	MFHEX2J
Alloy (A*)	\$56.45 /sf	MFHEX2A
Heritage (H)	\$56.45 /sf	MFHEX2H
Precocious (P)	\$56.45 /sf	MFHEX2P

Hexagon - 3.5"

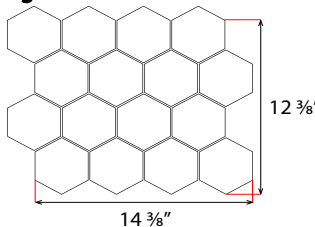

1.24 sf/sheet

5.3 lbs/sf

Standard (G, M, C, S*)	\$42.00 /sf	MFHEX35
Jewel & Quartz (J, Q)	\$48.30 /sf	MFHEX35J
Alloy (A*)	\$52.50 /sf	MFHEX35A
Heritage (H)	\$52.50 /sf	MFHEX35H
Wash (W) <i>Up to 25%</i>	\$52.50 /sf	MFHEX35W

Glaze Codes:

(A) Alloy **(C)** Crackle **(G)** Gloss **(H)** Heritage **(J)** Jewel **(M)** Matte **(P)** Precocious **(Q)** Quartz **(S)** Sheer **(W)** Wash

* Alloys & Sheers are not recommended for pools or spas. Sheers are not recommended for floors.

Hexagon - Skinny

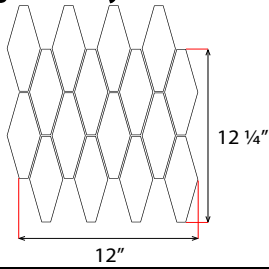

1.02 sq ft. per sheet

5.5 lbs/sf

Standard (G, M, C, S*)	\$48.30 /sf	MFHEXSK
Dimensional (G, M, H, C, S*)	\$55.55 /sf	MFHEXSKD
Jewel & Quartz (J, Q)	\$55.55 /sf	MFHEXSKJ
Alloy (A*)	\$60.40 /sf	MFHEXSKA
Heritage (H)	\$60.40 /sf	MFHEXSKH
Precocious (P)	\$60.40 /sf	MFHEXSKP

Juno

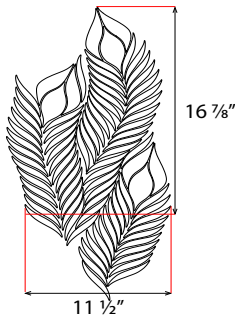

1.35 sf/sheet

4.8 lbs/sf

Standard (G, M, C, S*)	\$71.40 /sf	MFJUN
Dimensional (G, M, C, S*) <i>Wave only</i>	\$82.10 /sf	MFJUND
Jewel & Quartz (J, Q)	\$82.10 /sf	MFJUNJ
Precocious (P) <i>Wave only</i>	\$89.25 /sf	MFJUNP
Stone Basic <i>Up to 25%</i>	\$99.95 /sf	MFJUNS
Stone Prem <i>Calacatta/Thassos Up to 25%</i>	\$107.10 /sf	MFJUNSP

[Complete Specification Form](#)

Knitted Tide

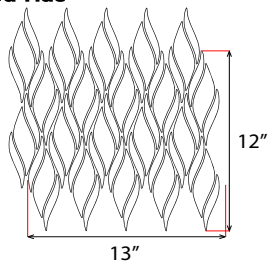

1.08 sf/sheet

3.4 lbs/sf

Standard (G, M, C, S*)	\$60.15 /sf	MFKT
Jewel & Quartz (J, Q)	\$69.15 /sf	MFKTJ

[Complete Specification Form](#)

Labyrinth

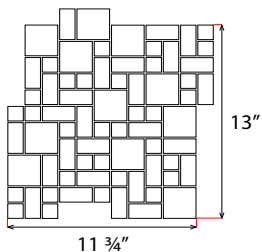

1.06 sf/sheet

3.4 lbs/sf

Standard (G, M, C, S*)	\$55.30 /sf	MFLAB
Jewel & Quartz (J, Q) <i>No 1x2</i>	\$63.60 /sf	MFLABJ
Alloy (A*) <i>2x2 only</i>	\$69.15 /sf	MFLABA
Heritage (H) <i>2x2 only</i>	\$69.15 /sf	MFLABH
Precocious (P) <i>2x2 only</i>	\$69.15 /sf	MFLABP

Matera

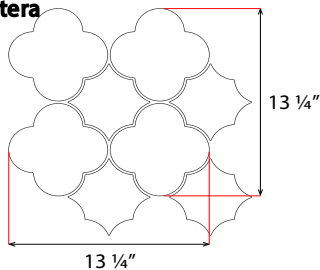

1.22 sf/sheet

5 lbs/sf

Standard (G, M, C, S*)	\$42.25 /sf	MFMTR
Alloy (A*)	\$52.80 /sf	MFMTRA
Heritage (H)	\$52.80 /sf	MFMTRH

[Complete Specification Form](#)

COMING LATE SUMMER 2024

Glaze Codes:

(A) Alloy **(C)** Crackle **(G)** Gloss **(H)** Heritage **(J)** Jewel **(M)** Matte **(P)** Precocious **(Q)** Quartz **(S)** Sheer **(W)** Wash

* Alloys & Sheers are not recommended for pools or spas. Sheers are not recommended for floors.

Miramar

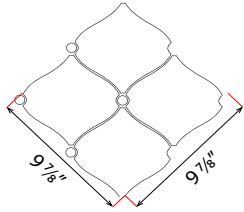

0.68 sf/sheet

5 lbs/sf

Standard (G, M, C, S*)	\$54.45 /sf	MF MIR
Dimensional (G, M, S*)	\$62.60 /sf	MF MIRD
Jewel & Quartz (J, Q) <i>No Buttons</i>	\$62.60 /sf	MF MIRJ
Alloy (A*)	\$68.05 /sf	MF MIRP
Stone Basic <i>Buttons only</i>	\$76.25 /sf	MF MIRS
Stone Premium Cal/Tha <i>Buttons only</i>	\$81.70 /sf	MF MIRSP

Monarch

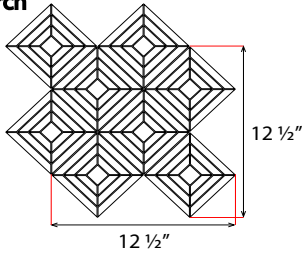

1.09 sf/sheet

4.6 lbs/sf

Standard (G, M, C, S*)	\$67.20 /sf	MF MON
------------------------	-------------	--------

[Complete Specification Form](#)

Monterrey

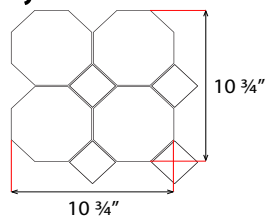

0.8 sf/sheet

4.5 lbs/sf

Standard (G, M, C, S*)	\$42.00 /sf	MF MOT
Alloy (A*)	\$52.50 /sf	MF MOTA
Heritage (H)	\$52.50 /sf	MF MOTH

[Complete Specification Form](#)

COMING LATE SUMMER 2024

Nova

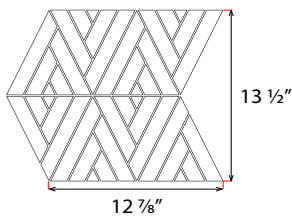

1.21 sf/sheet

4.6 lbs/sf

Standard (G, M, S*)	\$45.00 /sf	MF NOV
Alloy (A*)	\$56.25 /sf	MF NOVA

Octagon Weave

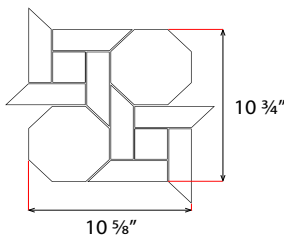

0.79 sf/sheet

3.5 lbs/sf

Standard (G, M, C, S*)	\$48.50 /sf	MF OCTW
Alloy (A*)	\$60.65 /sf	MF OCTWA
Heritage (H)	\$60.65 /sf	MF OCTWH

[Complete Specification Form](#)

COMING LATE SUMMER 2024

Ovals

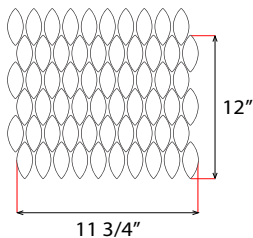

0.98 sf/sheet

4.5 lbs/sf

Standard (G, M, C, S*)	\$58.90 /sf	MF OVA
Alloy (A*)	\$73.65 /sf	MF OVAA
Heritage (H)	\$73.65 /sf	MF OVAH

Glaze Codes:

(A) Alloy (C) Crackle (G) Gloss (H) Heritage (J) Jewel (M) Matte (P) Precocious (Q) Quartz (S) Sheer (W) Wash

* Alloys & Sheers are not recommended for pools or spas. Sheers are not recommended for floors.

Picket - Small

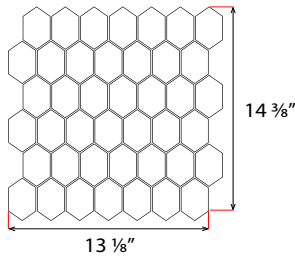

1.31 sf/sheet

5 lbs/sf

Standard (G, M, C, S*)	\$50.40 /sf	MFPICSM
Jewel & Quartz (J, Q)	\$57.95 /sf	MFPICSMJ
Alloy (A*)	\$63.00 /sf	MFPIC SMA
Heritage (H)	\$63.00 /sf	MFPICSMH
Stone Basic <i>Up to 25%</i>	\$70.55 /sf	MFPICSMS
Stone Prem <i>Calacatta/Thassos Up to 25%</i>	\$75.60 /sf	MFPICSMSP

Picket - Small Border

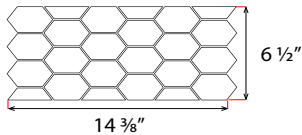

1.2 lf/sheet

2.3 lbs/lf

Standard (G, M, C, S*)	\$31.60 /lf	MBPICSM
Jewel & Quartz (J, Q)	\$36.35 /lf	MBPICSMJ
Alloy (A*)	\$39.50 /lf	MBPIC SMA
Heritage (H)	\$39.50 /lf	MBPICSMH

Plumage

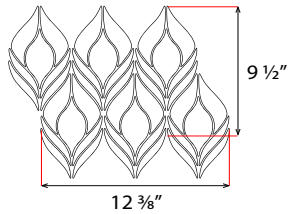

0.82 sf/sheet

4.2 lbs/sf

Standard (G, M, C, S*)	\$57.75 /sf	MFPLU
Dimensional (G, M, S*) <i>Wave only</i>	\$66.40 /sf	MFPLUD
Jewel & Quartz (J, Q)	\$66.40 /sf	MFPLUJ
Alloy (A*) <i>No Feathers</i>	\$72.20 /sf	MFPLUA
Precocious (P) <i>Wave only</i>	\$72.20 /sf	MFPLUP
Stone Basic <i>Up to 25%</i>	\$80.85 /sf	MFPLUS
Stone Prem <i>Calacatta/Thassos Up to 25%</i>	\$86.65 /sf	MFPLUSP

[Complete Specification Form](#)

Plumage Border

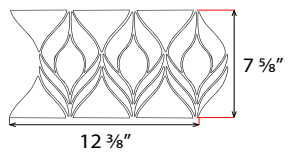

1.03 lf/sheet

2.4 lbs/lf

Standard (G, M, C, S*)	\$51.05 /lf	MBPLU
Dimensional (G, M, S*) <i>Wave only</i>	\$58.70 /lf	MBPLUD
Jewel & Quartz (J, Q)	\$58.70 /lf	MBPLUJ
Alloy (A*) <i>No Feathers</i>	\$63.80 /lf	MBPLUA
Precocious (P) <i>Wave only</i>	\$63.80 /lf	MBPLUP
Stone Basic <i>Up to 25%</i>	\$71.50 /lf	MBPLUS
Stone Prem <i>Calacatta/Thassos Up to 25%</i>	\$76.60 /lf	MBPLUSP

[Complete Specification Form](#)

Pointed Oval

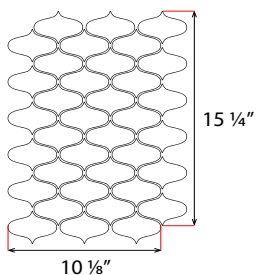

1.07 sf/sheet

5.3 lbs/sf

Standard (G, M, C, S*)	\$48.30 /sf	MFPO
Dimensional (G, M, C, H, S*)	\$55.55 /sf	MFPOD
Jewel & Quartz (J, Q)	\$55.55 /sf	MFPOJ
Alloy (A*)	\$60.40 /sf	MFPOA
Heritage (H)	\$60.40 /sf	MFPOH
Precocious (P)	\$60.40 /sf	MFPOP
Wash (W) <i>Up to 25%. No Mirage.</i>	\$60.40 /sf	MFPOW
Stone Basic <i>Up to 25%</i>	\$67.60 /sf	MFPOS
Stone Prem <i>Calacatta/Thassos Up to 25%</i>	\$72.45 /sf	MFPOSP

Glaze Codes:

(A) Alloy **(C)** Crackle **(G)** Gloss **(H)** Heritage **(J)** Jewel **(M)** Matte **(P)** Precocious **(Q)** Quartz **(S)** Sheer **(W)** Wash

* Alloys & Sheers are not recommended for pools or spas. Sheers are not recommended for floors.

Pointed Oval Border

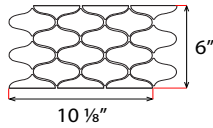

0.84 lf/sheet

3.3 lbs/lf

Standard (G, M, C, S*)	\$30.55 /lf	MBPOHR
Dimensional (G, M, H, S*) <i>No Halves</i>	\$35.15 /lf	MBPOHRD
Jewel & Quartz (J, Q)	\$35.15 /lf	MBPOHRJ
Alloy (A*)	\$38.20 /lf	MBPOHRA
Heritage (H)	\$38.20 /lf	MBPOHRH
Precocious (P)	\$38.20 /lf	MBPOHRP
Wash (W) <i>Up to 25%. No Mirage.</i>	\$38.20 /lf	MBPOHRW
Stone Basic <i>Up to 25%</i>	\$42.80 /lf	MBPOHRS
Stone Prem <i>Calacatta/Thassos Up to 25%</i>	\$45.85 /lf	MBPOHRSP

Quest

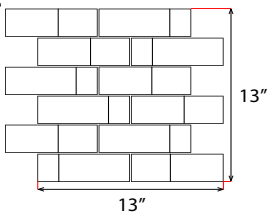

1.17 sf/sheet

4.6 lbs/sf

Standard (G, M, C, S*)	\$42.00 /sf	MFQUE
Alloy (A*)	\$52.50 /sf	MFQUEA
Heritage (H)	\$52.50 /sf	MFQUEH

Quest Mixed Broken Joint

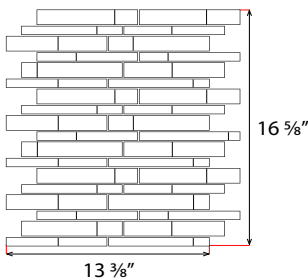

1.54 sf/sheet

6 lbs/sf

Standard (G, M, C, S*)	\$55.65 /sf	MFQUEXBJ
Alloy (A*)	\$69.55 /sf	MFQUEXBJA
Heritage (H)	\$69.55 /sf	MFQUEXBJH

Quest Mixed Stacked

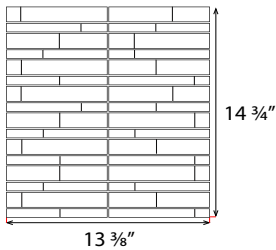

1.37 sf/sheet

6 lbs/sf

Standard (G, M, C, S*)	\$55.65 /sf	MFQUEMXST
Alloy (A*)	\$69.55 /sf	MFQUEMXSTA
Heritage (H)	\$69.55 /sf	MFQUEMXSTH

Quest Parquet

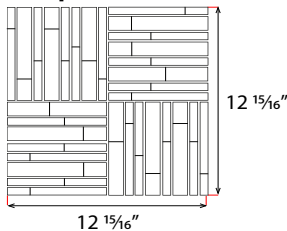

1.16 sf/sheet

6 lbs/sf

Standard (G, M, C, S*)	\$59.70 /sf	MFQUEPQ
Alloy (A*)	\$74.65 /sf	MFQUEPQA
Heritage (H)	\$74.65 /sf	MFQUEPQH

Riad

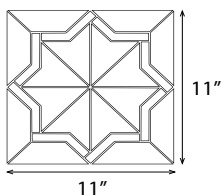

0.84 sf/sheet

4 lbs/sf

Standard (G, M, C, S*)	\$58.80 /sf	MFRIA
Jewel & Quartz (J, Q)	\$57.60 /sf	MFRIAJ
Alloy (A*)	\$73.50 /sf	MFRIAA
Heritage (H)	\$73.50 /sf	MFRIAH

[Complete Specification Form](#)

Glaze Codes:

(A) Alloy **(C)** Crackle **(G)** Gloss **(H)** Heritage **(J)** Jewel **(M)** Matte **(P)** Precocious **(Q)** Quartz **(S)** Sheer **(W)** Wash

* Alloys & Sheers are not recommended for pools or spas. Sheers are not recommended for floors.

Seville

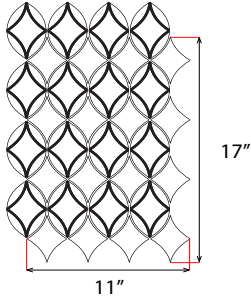

1.3 sf/sheet

Jewel & Quartz (J, Q)

4.5 lbs/sf

\$51.35 /sf

MFSEVJ

[Complete Specification Form](#)

Seville Large Border

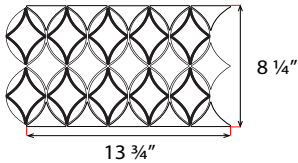

1.15 lf/sheet

Jewel & Quartz (J, Q)

3 lbs/lf

\$42.45 /lf

MBSEVLGJ

[Complete Specification Form](#)

Sublime

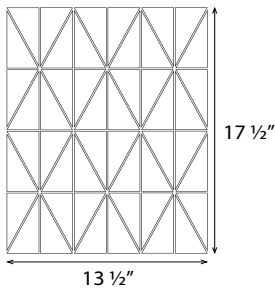

1.64 sf/sheet

Standard (G, M, C, S*)

4.2 lbs/sf

\$53.55 /sf

MFSUB

Tangier

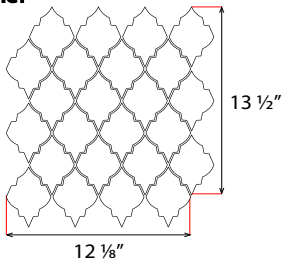

1.14 sf/sheet

Standard (G, M, C, S*)

4.5 lbs/sf

\$43.05

MFTAN

Alloy (A*)

\$53.80

MFTANA

Heritage (H)

\$53.80

MFTANH

Precocious (P)

\$53.80

MFTANP

Tangier Alternating

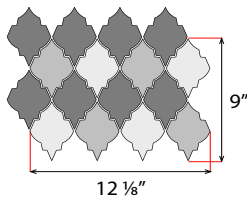

0.76 sf/sheet

Standard (G, M, C, S*)

4.5 lbs/sf

\$43.05

MFTANALT

Alloy (A*)

\$53.80

MFTANALTA

Heritage (H)

\$53.80

MFTANALTH

Precocious (P)

\$53.80

MFTANALTP

[Complete Specification Form](#)

Tide

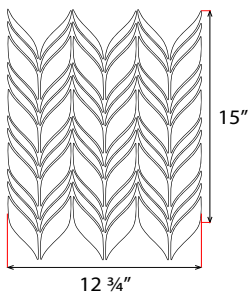

1.33 sf/sheet

Standard (G, M, C, S*)

3.9 lbs/sf

\$59.85 /sf

MFTID

Jewel & Quartz (J, Q)

\$68.85 /sf

MFTIDJ

[Complete Specification Form](#)

Glaze Codes:

(A) Alloy **(C)** Crackle **(G)** Gloss **(H)** Heritage **(J)** Jewel **(M)** Matte **(P)** Precocious **(Q)** Quartz **(S)** Sheer **(W)** Wash

* Alloys & Sheers are not recommended for pools or spas. Sheers are not recommended for floors.

Triangle 2" Standard

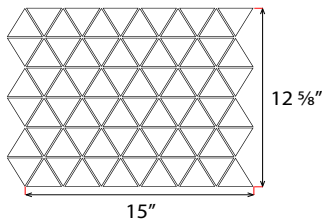

1.32 sf/sheet

5.7 lbs/sf

Standard (G, M, C, S*)	\$48.30 /sf	MFTRISM
Jewel & Quartz (J, Q)	\$55.55 /sf	MFTRISMJ
Alloy (A*)	\$60.40 /sf	MFTRISMA
Heritage (H)	\$60.40 /sf	MFTRISMH
Precocious (P)	\$60.40 /sf	MFTRISMP
Stone Basic <i>Up to 25%</i>	\$67.60 /sf	MFTRISMS
Stone Prem <i>Calacatta/Thassos Up to 25%</i>	\$72.45 /sf	MFTRISMSP

Tripoli

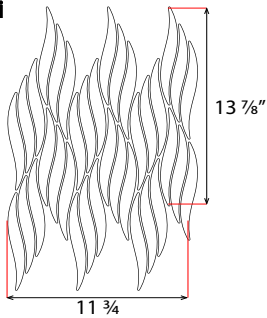

1.13 sf/sheet

4.2 lbs/sf

Standard (G, M, C, S*)	\$51.45 /sf	MFTRP
Jewel & Quartz (J, Q)	\$59.20 /sf	MFTRPJ

Versailles

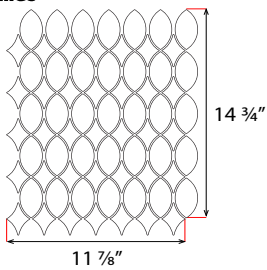

1.22 sf/sheet

4.1 lbs/sf

Standard (G, M, C, S*)	\$52.50 /sf	MFVER
Jewel & Quartz (J, Q)	\$60.40 /sf	MFVERJ
Alloy (A*)	\$65.65 /sf	MFVERA

[Complete Specification Form](#)

Versailles Border

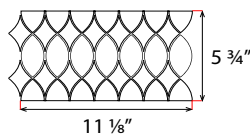

0.93 lf/sheet

3.4 lbs/lf

Standard (G, M, C, S*)	\$33.50 /lf	MBVER
Jewel & Quartz (J, Q)	\$38.55 /lf	MBVERJ
Alloy (A*)	\$41.90 /lf	MBVERA

[Complete Specification Form](#)

Wave

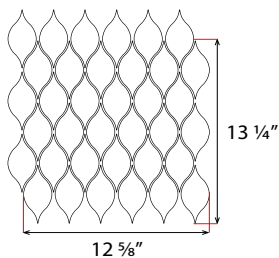

1.16 sf/sheet

5 lbs/sf

Standard (G, M, C, S*)	\$49.35 /sf	MFWAV
Dimensional (G, M, H, S*)	\$57.75 /sf	MFWAVD
Jewel & Quartz (J, Q)	\$57.75 /sf	MFWAVJ
Alloy (A*)	\$61.70 /sf	MFWAVA
Heritage (H)	\$61.70 /sf	MFWAVH
Precocious (P)	\$61.70 /sf	MFWAVP
Wash (W) <i>Up to 25%</i>	\$61.70 /sf	MFWAVW
Stone Basic <i>Up to 25%</i>	\$69.10 /sf	MFWAVS
Stone Prem <i>Calacatta/Thassos Up to 25%</i>	\$74.05 /sf	MFWAVSP
East Blend: <i>Calacatta, Thassos, Alabaster, Milk</i>	\$89.25 /sf	MFWAV EAST

Glaze Codes:

(A) Alloy **(C)** Crackle **(G)** Gloss **(H)** Heritage **(J)** Jewel **(M)** Matte **(P)** Precocious **(Q)** Quartz **(S)** Sheer **(W)** Wash

* Alloys & Sheers are not recommended for pools or spas. Sheers are not recommended for floors.

Wave Gradient

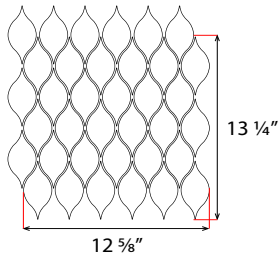

1.16 sf/sheet

Standard (G, M, C, S*)
Jewel & Quartz (J, Q)
Alloy (A*)
Heritage (H)
Precocious (P)
Wash (W) <i>Up to 25%</i>

5 lbs/sf

\$71.40 /sf	MFWAVGB
\$82.10 /sf	MFWAVGBJ
\$89.25 /sf	MFWAVGBA
\$89.25 /sf	MFWAVGBH
\$89.25 /sf	MFWAVGBP
\$89.25 /sf	MFWAVGBW

[Complete Specification Form](#)

Wave Horizontal Border

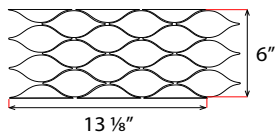

1.09 lf/sheet

Standard (G, M, C, S*)
Dimensional (G, M, H, S*) <i>No halves</i>
Jewel & Quartz (J, Q)
Alloy (A*)
Heritage (H)
Precocious (P)
Wash (W) <i>Up to 25%</i>

2.4 lbs/lf

\$30.40 /lf	MBWAVHR
\$34.95 /lf	MBWAVHRD
\$34.95 /lf	MBWAVHRJ
\$38.00 /lf	MBWAVHRA
\$38.00 /lf	MBWAVHRH
\$38.00 /lf	MBWAVHRP
\$38.00 /lf	MBWAVHRW

York

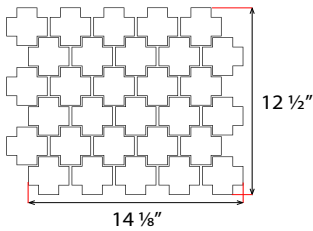

1.23 sf/sheet

Standard (G, M, C, S*)
Alloy (A*)

5 lbs/lf

\$45.15 /sf	MFYOR
\$56.45 /sf	MFYORA

Zig Zag Offset

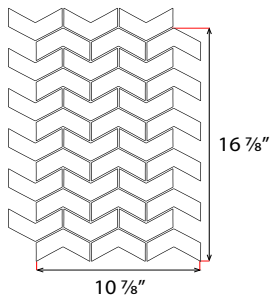

1.27 sf/sheet

Standard (G, M, C, S*)
Jewel & Quartz (J, Q)
Alloy (A*)

5.5 lbs/lf

\$45.15 /sf	MFZIGOFF
\$51.90 /sf	MFZIGOFFJ
\$56.45 /sf	MFZIGOFFA

Glaze Codes:







(A) Alloy **(C)** Crackle **(G)** Gloss **(H)** Heritage **(J)** Jewel **(M)** Matte **(P)** Precocious **(Q)** Quartz **(S)** Sheer **(W)** Wash
 * Alloys & Sheers are not recommended for pools or spas. Sheers are not recommended for floors.

Fully glazed edges are not guaranteed on moldings or liners.

Glazed edges available for \$12/edge upcharge.

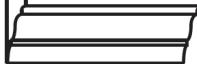
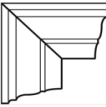
ENCORE CERAMICS

July 1, 2024 Wholesale Price List

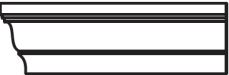
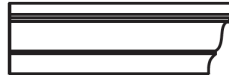
Assisi liner		1/2 x 6 1/2		0.15 lbs/pc	
	Standard (G, M, C, S)		\$10.45 /pc		L16ASS
	Jewel & Quartz (J, Q)		\$12.00 /pc		L16ASSJ
Benton liner		1/2 x 6 1/2		0.1 lbs/pc	
	Standard (G, M, C, S)		\$10.45 /pc		L16BEN
Byron liner		1/2 x 8 5/8		0.16 lbs/pc	
	Standard (G, M, C, S)		\$14.30 /pc		L18BYR
	Alloy (A*)		\$17.90 /pc		L18BYRA
	Heritage (H)		\$17.90 /pc		L18BYRH
	Wash (W)		\$17.90 /pc		L18BYRW
Charisma molding		2 1/4 x 6 3/8		0.65 lbs/pc	
	Standard (G, M, C, S)		\$15.95 /pc		M26CHA
	Heritage (H)		\$19.95 /pc		M26CHAH
	Wash (W)		\$19.95 /pc		M26CHAW
1 1/4" top profile, 3/8" bottom profile					
Charisma Frame Corner molding		3 1/4 x 3 1/4		0.4 lbs/pc	
	Standard (G, M, C, S)		\$29.45 /pc		MFC33CHA
	Heritage (H)		\$36.80 /pc		MFC33CHAH
	Wash (W)		\$36.80 /pc		MFC33CHAW
3 1/4" outside, 1" inside					
Cortona liner		1 x 6 3/4		0.2 lbs/pc	
	Standard (G, M, C, S)		\$10.45 /pc		L16COR
	Jewel & Quartz (J, Q)		\$12.00 /pc		L16CORJ
Ecstasy molding		3 1/8 x 8 3/8		1.25 lbs/pc	
	Standard (G, M, C, S)		\$20.65 /pc		M38ECS
	Heritage (H)		\$25.80 /pc		M38ECSH
	Wash (W)		\$25.80 /pc		M38ECSW
1 1/8" top profile, 3/8" bottom profile					
Ecstasy Frame Corner molding		4 1/8 x 4 1/8		0.45 lbs/pc	
	Standard (G, M, C, S)		\$31.65 /pc		MFC44ECS
	Heritage (H)		\$39.55 /pc		MFC44ECSH
	Wash (W)		\$39.55 /pc		MFC44ECSW
4 1/8" outside, 1" inside					
Ecstasy Stop End molding		3 1/8 x 8 3/8		1.25 lbs/pc	
Left		Standard (G, M, C, S)	Left	\$31.90 /pc	MLS38ECS
		Standard (G, M, C, S)	Right	\$31.90 /pc	MRS38ECS
Right		Heritage (H)	Left	\$39.90 /pc	MLS38ECSH
		Heritage (H)	Right	\$39.90 /pc	MRS38ECSH
		Wash (W)	Left	\$39.90 /pc	MLS38ECSW
		Wash (W)	Right	\$39.90 /pc	MRS38ECSW
8 1/4" outside, 7 1/2" inside width					

Glaze Codes:

(A) Alloy (C) Crackle (G) Gloss (H) Heritage (J) Jewel (M) Matte (P) Precocious (Q) Quartz (S) Sheer (W) Wash

* Alloys & Sheers are not recommended for pools or spas. Sheers are not recommended for floors.

Fully glazed edges are not guaranteed on moldings or liners.

Glazed edges available for \$12/edge upcharge.

ENCORE CERAMICS

July 1, 2024 Wholesale Price List

Essence molding

2 x 6 3/8

0.6 lbs/pc

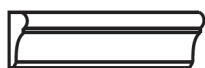

Standard (G, M, C, S)	\$14.85 /pc	M26ESS
Heritage (H)	\$18.55 /pc	M26ESSH
Wash (W)	\$18.55 /pc	M26ESSW

7/8" top profile, 3/8" bottom profile

Essence Arched Out molding

2 x 6 3/8

0.6 lbs/pc



Standard (G, M, C, S)	\$19.25 /pc	MA26ESS
Heritage (H)	\$24.05 /pc	MA26ESSH
Wash (W)	\$24.05 /pc	MA26ESSW

6 1/8" outside, 5 5/8" inside
20" to 23 1/4" outside, 18" to 21" inside radius

Essence Frame Corner molding

3 x 3

0.4 lbs/pc



3" outside, 1" inside

Standard (G, M, C, S)	\$28.05 /pc	MFC33ESS
Heritage (H)	\$35.05 /pc	MFC33ESSH
Wash (W)	\$35.05 /pc	MFC33ESSW

Essence Stop End molding

2 x 6 3/8

0.6 lbs/pc

Left

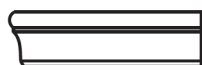

Standard (G, M, C, S) Left	\$25.60 /pc	MLS26ESS
Standard (G, M, C, S) Right	\$25.60 /pc	MRS26ESS

Right

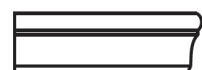

Heritage (H) Left	\$32.00 /pc	MLS26ESSH
Heritage (H) Right	\$32.00 /pc	MRS26ESSH
Wash (W) Left	\$32.00 /pc	MLS26ESSW
Wash (W) Right	\$32.00 /pc	MRS26ESSW

6 3/8 outside, 5 3/4" inside

Gibson molding

2 1/16 x 8 1/2

0.76 lbs/pc



5/8" top profile, 3/8" bottom profile

Standard (G, M, C, S)	\$16.80 /pc	M28GIB
Alloy (A*)	\$21.00 /pc	M28GIBA
Heritage (H)	\$21.00 /pc	M28GIBH
Precocious (P)	\$21.00 /pc	M28GIBP
Wash (W)	\$21.00 /pc	M28GIBW

Gibson Frame Corner molding

2 x 2

0.35 lbs/pc



3 1/16" outside, 1" inside

Standard (G, M, C, S)	\$28.05 /pc	MFC33GIB
Alloy (A*)	\$35.05 /pc	MFC33GIBA
Heritage (H)	\$35.05 /pc	MFC33GIBH
Precocious (P)	\$35.05 /pc	MFC33GIBP
Wash (W)	\$35.05 /pc	MFC33GIBW

Hadley liner

1/2 x 6 3/8

0.15 lbs/pc



Standard (G, M, C, S)	\$10.45 /pc	L16HAD
-----------------------	-------------	--------

Harmony molding

4 1/4 x 8 3/8

1.3 lbs/pc



3/8" top profile, 5/8" bottom profile

Standard (G, M, C, S)	\$23.10 /pc	M48HAR
Heritage (H)	\$28.90 /pc	M48HARH
Wash (W)	\$28.90 /pc	M48HARW

Glaze Codes:

(A) Alloy (C) Crackle (G) Gloss (H) Heritage (J) Jewel (M) Matte (P) Precocious (Q) Quartz (S) Sheer (W) Wash









* Alloys & Sheers are not recommended for pools or spas. Sheers are not recommended for floors.

Fully glazed edges are not guaranteed on moldings or liners.

Glazed edges available for \$12/edge upcharge.

ENCORE CERAMICS

July 1, 2024 Wholesale Price List

Joy liner 	1/2 x 6 3/8	0.15 lbs/pc	
	Standard (G, M, C, S)	\$10.45 /pc	L16JOY
	Jewel (J) <i>No Quartz</i>	\$12.00 /pc	L16JOYJ
	Heritage (H)	\$13.05 /pc	L16JOYH
	Precocious (P)	\$13.05 /pc	L16JOYP
	Wash (W)	\$13.05 /pc	L16JOYW
Landon Molding  1/2" top profile, 3/8" bottom profile	1 x 8 5/8	0.2 lbs/pc	
	Standard (G, M, C, S)	\$15.70 /pc	M18LAN
	Alloy (A*)	\$19.65 /pc	M18LANA
	Heritage (H)	\$19.65 /pc	M18LANH
	Precocious (P)	\$19.65 /pc	M18LANP
	Wash (W)	\$19.65 /pc	M18LANW
Larkin liner 	5/8 x 8 5/8	0.14 lbs/pc	
	Standard (G, M, C, S)	\$14.30 /pc	L18LAR
	Jewel (J) <i>No Quartz</i>	\$16.45 /pc	L18LARJ
	Heritage (H)	\$17.90 /pc	L18LARH
	Alloy (A*)	\$17.90 /pc	L18LARA
Lombard liner 	1/2 x 6 3/8	0.1 lbs/pc	
	Standard (G, M, C, S)	\$10.45 /pc	L16LOM
	Jewel (J) <i>No Quartz</i>	\$12.00 /pc	L16LOMJ
	Heritage (H)	\$13.05 /pc	L16LOMH
	Alloy (A*)	\$13.05 /pc	L16LOMA
Magic liner 	1/2 x 6 3/8	0.15 lbs/pc	
	Standard (G, M, C, S)	\$10.45 /pc	L16MAG
	Heritage (H)	\$13.05 /pc	L16MAGH
	Precocious (P)	\$13.05 /pc	L16MAGP
	Wash (W)	\$13.05 /pc	L16MAGW
Melville liner 	1 x 8 5/8	0.28 lbs/pc	
	Standard (G, M, C, S)	\$11.55 /pc	L18MEL
	Alloy (A*)	\$14.45 /pc	L18MELA
	Heritage (H)	\$14.45 /pc	L18MELH
Palermo liner 	1 1/8 x 6 3/8	0.2 lbs/pc	
	Standard (G, M, C, S)	\$10.45 /pc	L16PAL
	Jewel & Quartz (J, Q)	\$12.00 /pc	L16PALJ
Peace liner 	1/2 x 6 3/8	0.15 lbs/pc	
	Standard (G, M, C, S)	\$10.45 /pc	L16PEA
	Jewel (J) <i>No Quartz</i>	\$12.00 /pc	L16PEAJ
	Heritage (H)	\$13.05 /pc	L16PEAH
	Precocious (P)	\$13.05 /pc	L16PEAP
	Wash (W)	\$13.05 /pc	L16PEAW

Glaze Codes:

(A) Alloy (C) Crackle (G) Gloss (H) Heritage (J) Jewel (M) Matte (P) Precocious (Q) Quartz (S) Sheer (W) Wash

* Alloys & Sheers are not recommended for pools or spas. Sheers are not recommended for floors.

Fully glazed edges are not guaranteed on moldings or liners.

Glazed edges available for \$12/edge upcharge.

ENCORE CERAMICS

July 1, 2024 Wholesale Price List

 7/8" top profile, 3/8" bottom profile	Positano molding	1 1/2 x 6 3/8	0.4 lbs/pc
		Standard (G, M, C, S)	\$14.30 /pc M16POS
		Jewel & Quartz (J, Q)	\$16.45 /pc M16POSJ
		Heritage (H)	\$17.90 /pc M16POSH
		Precocious (P)	\$17.90 /pc M16POSP
		Wash (W)	\$17.90 /pc M16POSW

 2 1/2" outside, 1" inside	Positano Frame Corner molding	2 x 2	0.3 lbs/pc
		Standard (G, M, C, S)	\$25.60 /pc MFC22POS
		Jewel & Quartz (J, Q)	\$29.45 /pc MFC22POSJ
		Heritage (H)	\$32.00 /pc MFC22POSH
		Precocious (P)	\$32.00 /pc MFC22POSP
		Wash (W)	\$32.00 /pc MFC22POSW

	Sardinia liner	1/2 x 6 3/8	0.1 lbs/pc
		Standard (G, M, C, S)	\$10.45 /pc L16SAR

 1/2" top profile, 3/8" bottom profile	Surprise molding	3/4 x 6 3/8	0.2 lbs/pc
		Standard (G, M, C, S)	\$12.95 /pc M16SUR
		Heritage (H)	\$16.20 /pc M16SURH
		Precocious (P)	\$16.20 /pc M16SURP
			Wash (W)

 7/8" top profile, 3/8" bottom profile	Turin molding	2 1/8 x 6 3/8	0.5 lbs/pc
		Standard (G, M, C, S)	\$15.70 /pc M26TUR
		Jewel & Quartz (J, Q)	\$18.05 /pc M26TURJ
		Heritage (H)	\$19.65 /pc M26TURH
		Precocious (P)	\$19.65 /pc M26TURP
		Wash (W)	\$19.65 /pc M26TURW

 3 1/8" outside, 1" inside	Turin Frame Corner molding	3x3	0.4 lbs/pc
		Standard (G, M, C, S)	\$28.05 /pc MFC33TUR
		Jewel & Quartz (J, Q)	\$32.25 /pc MFC33TURJ
		Heritage (H)	\$35.05 /pc MFC33TURH
		Precocious (P)	\$35.05 /pc MFC33TURP
		Wash (W)	\$35.05 /pc MFC33TURW

	Weston molding	6 1/8 x 8 5/8	1.8 lbs/pc
		Standard (G, M, C, S)	\$24.15 /pc M68WES
		Heritage (H)	\$30.20 /pc M68WESH
		Wash (W)	\$30.20 /pc M68WESW

3/8" top profile, 3/8" bottom profile

Glaze Codes:

(A) Alloy (C) Crackle (G) Gloss (H) Heritage (J) Jewel (M) Matte (P) Precocious (Q) Quartz (S) Sheer (W) Wash

* Alloys & Sheers are not recommended for pools or spas. Sheers are not recommended for floors.

All deco motifs sold by the piece. No minimums. Glazed edges available on some borders. Glazed edges available for \$12/edge upcharge.

Adventure border



	2 1/8 x 8 3/8		0.5 lbs/pc	
Standard (G, M, C, S*)		\$17.35 /pc		B28ADV
Jewel (J) <i>No Quartz</i>		\$19.95 /pc		B28ADVJ
Wash (W)		\$21.70 /pc		B28ADVW

Anticipation deco field



	4 1/4 x 4 1/4	8 pcs/sf		0.5 lbs/pc	
Standard (G, M, C, S*)			\$6.80 /pc	\$54.40 /sf	DF44ANT
Jewel & Quartz (J*, Q)			\$7.80 /pc	\$62.40 /sf	DF44ANTJ
Alloy (A*)			\$8.50 /pc	\$68.00 /sf	DF44ANTA
Heritage (H) <i>No Dove</i>			\$8.50 /pc	\$68.00 /sf	DF44ANTH
Precocious (P)			\$8.50 /pc	\$68.00 /sf	DF44ANTP
Wash (W)			\$8.50 /pc	\$68.00 /sf	DF44ANTW

Armstrong 2x6 Textured Field

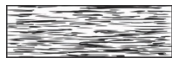

	2 1/8 x 6 3/8	11 pcs/sf		0.4 lbs/pc	
Standard (G, M, C, S*)			\$3.85 /pc	\$42.35 /sf	FT26ARM
Alloy (A*)			\$4.80 /pc	\$52.80 /sf	FT26ARMA
Heritage (H) <i>No Dove</i>			\$4.80 /pc	\$52.80 /sf	FT26ARMH

Armstrong 2x8 Textured Field



	2 1/8 x 8 5/8	8 pcs/sf		0.6 lbs/pc	
Standard (G, M, C, S*)			\$5.70 /pc	\$45.60 /sf	FT28ARM
Alloy (A*)			\$7.15 /pc	\$57.20 /sf	FT28ARMA
Heritage (H) <i>No Dove</i>			\$7.15 /pc	\$57.20 /sf	FT28ARMH

Armstrong 3x8 Textured Field

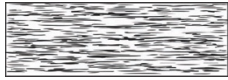

	3 1/8 x 8 5/8	5.25 pcs/sf		0.72 lbs/pc	
Standard (G, M, C, S*)			\$7.25 /pc	\$38.06 /sf	FT38ARM
Alloy (A*)			\$9.05 /pc	\$47.51 /sf	FT38ARMA
Heritage (H) <i>No Dove</i>			\$9.05 /pc	\$47.51 /sf	FT38ARMH

Armstrong 4x10 Textured Field

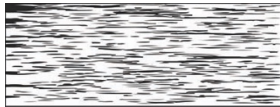

	4 1/4 x 10 3/8	3.25 pcs/sf		1.3 lbs/pc	
Standard (G, M, C, S*)			\$15.20 /pc	\$49.40 /sf	FT410ARM
Alloy (A*)			\$19.00 /pc	\$61.75 /sf	FT410ARMA
Heritage (H) <i>No Dove</i>			\$19.00 /pc	\$61.75 /sf	FT410ARMH

Arno Plant-on deco



	2 5/8 x 2 5/8		0.25 lbs/pc	
Standard (G, M, C, S*)		\$12.95 /pc		D33ARN
Jewel & Quartz (J*, Q)		\$14.90 /pc		D33ARNJ

Astor Part 1 & 2 deco field

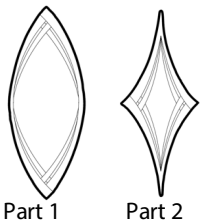

	3 1/2 x 8 5/8	9.52 pcs/sf		0.7 lbs/pc	
Standard (G, M, C, S*) part 1			\$6.95 /pc	<i>Pattern Price:</i>	DFAST1
Standard (G, M, C, S*) part 2			\$6.95 /pc	\$66.16 /sf	DFAST2

Sold per piece. One set contains one piece of each part and there are 4.76 sets/sf. To figure pieces needed:
Example: 10 sf x 4.76 sets per sf = 47.6 sets. Order 48 pcs of each part.

Beauty deco



	2 1/8 x 2 1/8		0.15 lbs/pc	
Standard (G, M, C, S*)		\$6.95 /pc		D22BEA
Jewel (J) <i>No Quartz</i>		\$8.00 /pc		D22BEAJ
Precocious (P)		\$8.70 /pc		D22BEAP
Wash (W) <i>No Mirage</i>		\$8.70 /pc		D22BEAW

Glaze Codes:

(A) Alloy (C) Crackle (G) Gloss (H) Heritage (J) Jewel (M) Matte (P) Precocious (Q) Quartz (S) Sheer (W) Wash

* Alloys & Sheers are not recommended for pools or spas. Sheers are not recommended for floors.

All deco motifs sold by the piece. No minimums. Glazed edges available on some borders. Glazed edges available for \$12/edge upcharge.

Bergamo deco



2 1/8 x 2 1/8

0.15 lbs/pc

Standard (G, M, C, S*)	\$6.60 /pc	D22BER
Jewel & Quartz (J*, Q)	\$7.60 /pc	D22BERJ

Bliss border



4 x 10 1/2

1.4 lbs/pc

Standard (G, M, C, S*)	\$21.20 /pc	B410BLI
Jewel & Quartz (J, Q)	\$24.40 /pc	B410BLIJ
Precocious (P)	\$26.50 /pc	B410BLIP
Wash (W)	\$26.50 /pc	B410BLIW

Bohemia border



3 1/8 x 8 3/8

0.65 lbs/pc

Standard (G, M, C, S*)	\$18.15 /pc	B38BOH
Jewel & Quartz (J, Q)	\$20.00 /pc	B38BOHJ
Precocious (P)	\$22.70 /pc	B38BOHP
Wash (W)	\$22.70 /pc	B38BOHW

Bronte border



3 3/4 x 9 1/8

0.7 lbs/pc

Standard (G, M, C, S*)	\$14.85 /pc	B39BRO
------------------------	-------------	--------

Browning deco field



3 1/8 x 8 5/8

5.24 pcs/sf

0.78 lbs/pc

Standard (G, M, C, S*)	\$7.15 /pc	\$37.47 /sf	DF38BRO
------------------------	------------	-------------	---------

Burton 2x6 Textured Field

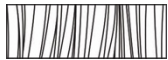

2 1/8 x 6 3/8

11 pcs/sf

0.4 lbs/pc

Standard (G, M, C, S*)	\$3.85 /pc	\$42.35 /sf	FT26BUR
Alloy (A*)	\$4.80 /pc	\$52.80 /sf	FT26BURA
Heritage (H) <i>No Dove</i>	\$4.80 /pc	\$52.80 /sf	FT26BURH

Burton 2x8 Textured Field



2 1/8 x 8 5/8

8 pcs/sf

0.6 lbs/pc

Standard (G, M, C, S*)	\$5.70 /pc	\$45.60 /sf	FT28BUR
Alloy (A*)	\$7.15 /pc	\$57.20 /sf	FT28BURA
Heritage (H) <i>No Dove</i>	\$7.15 /pc	\$57.20 /sf	FT28BURH

Burton 3x8 Textured Field



3 1/8 x 8 5/8

5.25 pcs/sf

0.72 lbs/pc

Standard (G, M, C, S*)	\$7.25 /pc	\$38.06 /sf	FT38BUR
Alloy (A*)	\$9.05 /pc	\$47.51 /sf	FT38BURA
Heritage (H) <i>No Dove</i>	\$9.05 /pc	\$47.51 /sf	FT38BURH

Burton 4x10 Textured Field

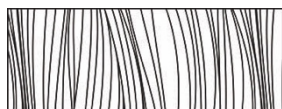

4 1/4 x 10 3/8

3.3 pcs/sf

1.3 lbs/pc

Standard (G, M, C, S*)	\$15.20 /pc	\$50.16 /sf	FT410BUR
Alloy (A*)	\$19.00 /pc	\$62.70 /sf	FT410BURA
Heritage (H) <i>No Dove</i>	\$19.00 /pc	\$62.70 /sf	FT410BURH

Glaze Codes:

(A) Alloy (C) Crackle (G) Gloss (H) Heritage (J) Jewel (M) Matte (P) Precocious (Q) Quartz (S) Sheer (W) Wash

* Alloys & Sheers are not recommended for pools or spas. Sheers are not recommended for floors.

All deco motifs sold by the piece. No minimums. Glazed edges available on some borders. Glazed edges available for \$12/edge upcharge.

Casablanca deco field



6 x 6 3/4		6.6 pcs/sf	0.8 lbs/pc	
Standard (G, M, C, S*)		\$9.90 /pc	\$65.34 /sf	DFCAS
Jewel & Quartz (J, Q)		\$11.40 /pc	\$75.24 /sf	DFCASJ

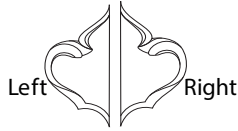

3 x 6 3/4		0.4 lbs/pc		
Standard (G, M, C, S*)	Left	\$9.90 /pc		DFCASL
Standard (G, M, C, S*)	Right	\$9.90 /pc		DFCASR
Jewel & Quartz (J, Q)	Left	\$11.40 /pc		DFCASLJ
Jewel & Quartz (J, Q)	Right	\$11.40 /pc		DFCASRJ

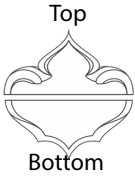

6 x 3 3/4		0.4 lbs/pc		
Standard (G, M, C, S*)	Top	\$9.90 /pc		DFCAST
Standard (G, M, C, S*)	ottom	\$9.90 /pc		DFCASB
Jewel & Quartz (J, Q)	Top	\$11.40 /pc		DFCASTJ
Jewel & Quartz (J, Q)	ottom	\$11.40 /pc		DFCASBJ

Compassion plaque

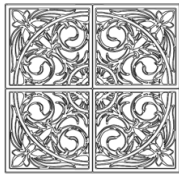

13 x 13		5.15 lbs/set		
Standard (G, M, C, S*)		\$264.00 /set of 4		P1313COM
Jewel & Quartz (J*, Q)		\$303.60 /set of 4		P1313COMJ
Alloy (A*)	<i>Bronze Only</i>	\$330.00 /set of 4		P1313COMA

Corsica border



3 1/8 x 9 7/8		0.85 lbs/pc		
Standard (G, M, C, S*)		\$18.15 /pc		B310COR
Jewel & Quartz (J*, Q)		\$20.90 /pc		B310CORJ

Descanso deco field



6 1/2 x 10 1/4		4.33 pcs/sf	0.8 lbs/pc	
Standard (G, M, C, S*)		\$12.40 /pc	\$53.69 /sf	DFDES
Alloy (A*)		\$15.50 /pc	\$67.12 /sf	DFDESA
Heritage (H)	<i>No Dove</i>	\$15.50 /pc	\$67.12 /sf	DFDESH

Destiny border



5 x 10 1/2		1.6 lbs/pc		
Standard (G, M, C, S*)		\$23.10 /pc		B510DES
Jewel & Quartz (J, Q)		\$26.60 /pc		B510DESJ
Heritage (H)	<i>No Dove</i>	\$28.90 /pc		B510DESH

Elliot 2x6 Textured Field Tile



2 1/8 x 6 3/8		11 pcs/sf	0.4 lbs/pc	
Standard (G, M, C, S*)		\$3.85 /pc	\$42.35 /sf	FT26ELI
Alloy (A*)		\$4.80 /pc	\$52.80 /sf	FT26ELIA
Heritage (H)	<i>No Dove</i>	\$4.80 /pc	\$52.80 /sf	FT26ELIH

Glaze Codes:

(A) Alloy (C) Crackle (G) Gloss (H) Heritage (J) Jewel (M) Matte (P) Precocious (Q) Quartz (S) Sheer (W) Wash

* Alloys & Sheers are not recommended for pools or spas. Sheers are not recommended for floors.

All deco motifs sold by the piece. No minimums. Glazed edges available on some borders. Glazed edges available for \$12/edge upcharge.

Elliot 2x8 Textured Field Tile

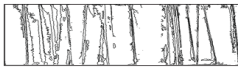

2 1/8 x 8 5/8 **8 pcs/sf** **0.6 lbs/pc**

Standard (G, M, C, S*)	\$5.70 /pc	\$45.60 /sf	FT28ELI
Alloy (A*)	\$7.15 /pc	\$57.20 /sf	FT28ELIA
Heritage (H) <i>No Dove</i>	\$7.15 /pc	\$57.20 /sf	FT28ELIH

Elliot 3x8 Textured Field Tile



3 1/8 x 8 5/8 **5.25 pcs/sf** **0.72 lbs/pc**

Standard (G, M, C, S*)	\$7.25 /pc	\$38.06 /sf	FT38ELI
Alloy (A*)	\$9.05 /pc	\$47.51 /sf	FT38ELIA
Heritage (H) <i>No Dove</i>	\$9.05 /pc	\$47.51 /sf	FT38ELIH

Elliot 4x10 Textured Field Tile

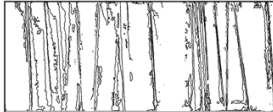

4 1/4 x 10 3/8 **3.25 pcs/sf** **1.3 lbs/pc**

Standard (G, M, C, S*)	\$15.20 /pc	\$49.40 /sf	FT410ELI
Alloy (A*)	\$19.00 /pc	\$61.75 /sf	FT410ELIA
Heritage (H) <i>No Dove</i>	\$19.00 /pc	\$61.75 /sf	FT410ELIH

Enchantment deco

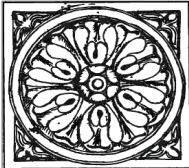

6 3/8 x 6 3/8 **1.55 lbs/pc**

Standard (G, M, C, S*)	\$19.25 /pc	D66ENC
Alloy (A*) <i>Bronze Only</i>	\$24.05 /pc	D66ENCA
Heritage (H) <i>No Dove</i>	\$24.05 /pc	D66ENCH
Wash (W)	\$24.05 /pc	D66ENCW

Etna Plant-on deco



3 1/4 x 3 1/4 **0.25 lbs/pc**

Standard (G, M, C, S*)	\$12.95 /pc	D33ETN
Jewel & Quartz (J*, Q)	\$14.90 /pc	D33ETNJ

Eton deco



2 1/8 x 2 1/8 **0.15 lbs/pc**

Standard (G, M, C, S*)	\$6.60 /pc	D22ETO
------------------------	------------	--------

Ferrara border



6 3/8 x 8 1/2 **1.55 lbs/pc**

Standard (G, M, C, S*)	\$23.10 /pc	B68FER
Jewel & Quartz (J*, Q)	\$26.60 /pc	B68FERJ

Firenze border

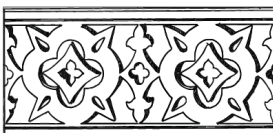

4 1/4 x 9 1/4 **1.1 lbs/pc**

Standard (G, M, C, S*)	\$19.25 /pc	B49FIR
Jewel & Quartz (J*, Q)	\$24.05 /pc	B49FIRJ

Flair deco field

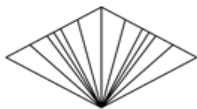

3 5/8 x 6 1/8 **12.1 pcs/sf** **0.6 lbs/pc**

Standard (G, M, C, S*)	\$4.00 /pc	\$48.44 /sf	DFFLR
Alloy (A*)	\$5.00 /pc	\$60.55 /sf	DFFLRA
Heritage (H) <i>No Dove</i>	\$5.00 /pc	\$60.55 /sf	DFFLRH

Glaze Codes:

(A) Alloy (C) Crackle (G) Gloss (H) Heritage (J) Jewel (M) Matte (P) Precocious (Q) Quartz (S) Sheer (W) Wash

* Alloys & Sheers are not recommended for pools or spas. Sheers are not recommended for floors.

All deco motifs sold by the piece. No minimums. Glazed edges available on some borders. Glazed edges available for \$12/edge upcharge.

ENCORE CERAMICS
July 1, 2024 Wholesale Price List

Genoa deco



4 1/4 x 4 1/4

0.6 lbs/pc

Standard (G, M, C, S*)	\$12.95 /pc	D44GEN
Jewel & Quartz (J*, Q)	\$14.90 /pc	D44GENJ
Precocious (P)	\$16.20 /pc	D44GENP
Wash (W)	\$16.20 /pc	D44GENW

Grace Corner plaque



17 1/2 x 17 1/2

9.2 lbs/set

Standard (G, M, C, S*)	\$330.00 /set of 4	PGRA4
Jewel & Quartz (J*, Q)	\$379.60 /set of 4	PGRA4J
Alloy (A*) <i>Bronze Only</i>	\$412.60 /set of 4	PGRA4A

Grace 6 piece plaque

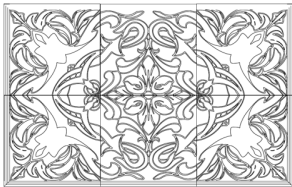

17 1/2 x 26

13.8 lbs/set

Standard (G, M, C, S*)	\$495.00 /set of 6	PGRA6
Jewel & Quartz (J*, Q)	\$569.40 /set of 6	PGRA6J
Alloy (A*) <i>Bronze Only</i>	\$618.90 /set of 6	PGRA6A

Grace 9 piece plaque

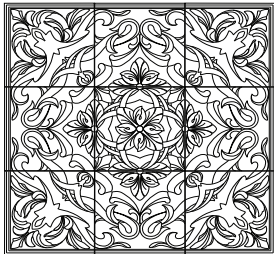

26 x 26

20.7 lbs/set

Standard (G, M, C, S*)	\$742.50 /set of 9	PGRA9
Jewel & Quartz (J*, Q)	\$854.10 /set of 9	PGRA9J
Alloy (A*) <i>Bronze Only</i>	\$928.35 /set of 9	PGRA9A

Grace 2 piece insert / extension



17 1/2 x 8 3/4

4.6 lbs/set

Standard (G, M, C, S*)	\$165.00 /set of 2	PEGRA2
Jewel & Quartz (J*, Q)	\$189.80 /set of 2	PEGRA2J
Alloy (A*) <i>Bronze Only</i>	\$206.30 /set of 2	PEGRA2A

Grace Flower



8 3/4 x 8 3/4

2.3 lbs/pc

Standard (G, M, C, S*)	\$82.50 /pc	P88GFLO
Jewel & Quartz (J*, Q)	\$94.90 /pc	P88GFLOJ
Alloy (A*) <i>Bronze Only</i>	\$103.15 /pc	P88GFLOA

Harvard deco



2 1/8 x 2 1/8

0.15 lbs/pc

Standard (G, M, C, S*)	\$6.60 /pc	D22HAR
------------------------	------------	--------









Glaze Codes:

(A) Alloy (C) Crackle (G) Gloss (H) Heritage (J) Jewel (M) Matte (P) Precocious (Q) Quartz (S) Sheer (W) Wash

* Alloys & Sheers are not recommended for pools or spas. Sheers are not recommended for floors.

All deco motifs sold by the piece. No minimums. Glazed edges available on some borders. Glazed edges available for \$12/edge upcharge.

ENCORE CERAMICS
July 1, 2024 Wholesale Price List

Integrity deco 	3 cm x 3 cm		0.04 lbs/pc	
	Standard (G, M, C, S*)		\$5.35 /pc	D11INT
Kent deco 	1 x 1		0.04 lbs/pc	
	Standard (G, M, C, S*)		\$5.35 /pc	D11KEN
Lazio deco 	4 1/4 x 4 1/4		0.6 lbs/pc	
	Standard (G, M, C, S*)		\$12.95 /pc	D44LAZ
	Jewel & Quartz (J*, Q)		\$14.85 /pc	D44LAZJ
Liberty border 	4 1/4 x 8 3/8		0.6 lbs/pc	
	Standard (G, M, C, S*)		\$19.25 /pc	B48LIB
	Jewel & Quartz (J, Q)		\$22.15 /pc	B48LIBJ
	Alloy (A*) <i>Bronze Only</i>		\$24.05 /pc	B48LIBA
	Heritage (H) <i>No Dove</i>		\$24.05 /pc	B48LIBH
	Precocious (P)		\$24.05 /pc	B48LIBP
	Wash (W)		\$24.05 /pc	B48LIBW
Liguria deco 	3 1/8 x 3 1/8		0.25 lbs/pc	
	Standard (G, M, C, S*)		\$9.35 /pc	D33LIG
	Jewel & Quartz (J, Q)		\$10.75 /pc	D33LIGJ
	Alloy (A*) <i>Bronze Only</i>		\$11.70 /pc	D33LIGA
	Heritage (H) <i>No Dove</i>		\$11.70 /pc	D33LIGH
	Precocious (P)		\$11.70 /pc	D33LIGP
	Wash (W)		\$11.70 /pc	D33LIGW
Lisbon deco field 	4 1/4 x 4 1/4	8 pcs/sf	0.6 lbs/pc	
	Standard (G, M, C, S*)		\$6.80 /pc	\$54.40 /sf DF44LIS
	Jewel & Quartz (J*, Q)		\$7.82 /pc	\$62.56 /sf DF44LISJ
	Alloy (A*) <i>Bronze Only</i>		\$8.50 /pc	\$68.00 /sf DF44LISA
	Heritage (H) <i>No Dove</i>		\$8.50 /pc	\$68.00 /sf DF44LISH
	Precocious (P)		\$8.50 /pc	\$68.00 /sf DF44LISP
Lotus deco field 	6 3/8 x 6 3/8	7.4 pieces per sq ft	0.8 lbs/pc	
	Standard (G, M, C, S*)		\$8.00 /pc	\$59.20 /sf DFLOT
	Alloy (A*)		\$10.00 /pc	\$74.00 /sf DFLOTA
	Heritage (H) <i>No Dove</i>		\$10.00 /pc	\$74.00 /sf DFLOTH
Lumiere deco field 	3 3/4 x 7 7/8	6.46 pieces per sq ft	0.6 lbs/pc	
	Standard (G, M, C, S*)		\$7.70 /pc	\$49.74 /sf DFLUM
	Alloy (A*) <i>Bronze Only</i>		\$9.65 /pc	\$62.34 /sf DFLUMA
	Heritage (H) <i>No Dove</i>		\$9.65 /pc	\$62.34 /sf DFLUMH

Glaze Codes:

(A) Alloy (C) Crackle (G) Gloss (H) Heritage (J) Jewel (M) Matte (P) Precocious (Q) Quartz (S) Sheer (W) Wash

* Alloys & Sheers are not recommended for pools or spas. Sheers are not recommended for floors.

All deco motifs sold by the piece. No minimums. Glazed edges available on some borders. Glazed edges available for \$12/edge upcharge.

ENCORE CERAMICS
July 1, 2024 Wholesale Price List

Manarola deco field

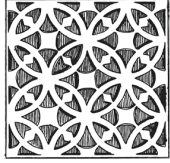

6 3/8 x 6 3/8	3.55 pcs/sf	1.33 lbs/pc	
Standard (G, M, C, S*)	\$13.90 /pc	\$49.35 /sf	DF66MAN
Jewel & Quartz (J*, Q)	\$16.00 /pc	\$56.80 /sf	DF66MANJ

Maverick deco field

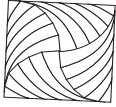

4 1/4 x 4 1/4	8 pcs/sf	0.6 lbs/pc	
Standard (G, M, C, S*)	\$6.80 /pc	\$54.40 /sf	DF44MAV
Alloy (A*)	\$8.50 /pc	\$68.00 /sf	DF44MAVA
Heritage (H) <i>No Dove</i>	\$8.50 /pc	\$68.00 /sf	DF44MAVH

Normandy deco



1 x 1		0.04 lbs/pc	
Standard (G, M, C, S*)	\$5.35 /pc		D11NOR

Ovation border



3 1/4 x 9 3/8		0.95 lbs/pc	
Standard (G, M, C, S*)	\$18.15 /pc		B39OVA
Jewel & Quartz (J*, Q)	\$20.90 /pc		B39OVAJ
Heritage (H) <i>No Dove</i>	\$22.70 /pc		B39OVAH
Precocious (P)	\$22.70 /pc		B39OVAP
Wash (W)	\$22.70 /pc		B39OVAW

Ovation Frame Corner



4 x 4		0.5 lbs/pc	
Standard (G, M, C, S*)	\$25.60 /pc		BC44OVA
Jewel & Quartz (J*, Q)	\$29.45 /pc		BC44OVAJ
Heritage (H) <i>No Dove</i>	\$32.00 /pc		BC44OVAH
Precocious (P)	\$32.00 /pc		BC44OVAP
Wash (W)	\$32.00 /pc		BC44OVAW

Palma deco field



6 1/2 x 8 3/4	2.53 pcs/sf	1.55 lbs/pc	
Standard (G, M, C, S*)	\$20.35 /pc	\$51.49 /sf	DF68PAL
Alloy (A*) <i>Bronze Only</i>	\$25.45 /pc	\$64.39 /sf	DF68PALA
Heritage (H) <i>No Dove</i>	\$25.45 /pc	\$64.39 /sf	DF68PALH

Passion deco



4 1/4 x 4 1/4		0.6 lbs/pc	
Standard (G, M, C, S*)	\$12.95 /pc		D44PAS
Jewel & Quartz (J*, Q)	\$14.90 /pc		D44PASJ
Precocious (P)	\$16.20 /pc		D44PASP
Wash (W)	\$16.20 /pc		D44PASW

Pisa deco



2 1/8 x 2 1/8		0.15 lbs/pc	
Standard (G, M, C, S*)	\$6.60 /pc		D22PIS
Jewel & Quartz (J, Q)	\$7.60 /pc		D22PISJ
Alloy (A*) <i>Bronze Only</i>	\$8.25 /pc		D22PISA

Porto deco field



4 1/4 x 4 1/4	8 pcs/sf	0.6 lbs/pc	
Standard (G, M, C, S*)	\$6.80 /pc	\$54.40 /sf	DF44POR
Jewel & Quartz (J*, Q)	\$7.82 /pc	\$62.56 /sf	DF44PORJ
Heritage (H) <i>No Dove</i>	\$8.50 /pc	\$68.00 /sf	DF44PORH

Glaze Codes:

(A) Alloy (C) Crackle (G) Gloss (H) Heritage (J) Jewel (M) Matte (P) Precocious (Q) Quartz (S) Sheer (W) Wash

* Alloys & Sheers are not recommended for pools or spas. Sheers are not recommended for floors.

All deco motifs sold by the piece. No minimums. Glazed edges available on some borders. Glazed edges available for \$12/edge upcharge.

Prato border



	2 1/8 x 8 1/2	0.5 lbs/pc	
Standard (G, M, C, S*)	\$17.35 /pc		B28PRA
Jewel & Quartz (J*, Q)	\$19.95 /pc		B28PRAJ

Purity deco



	3 cm x 3cm	0.04 lbs/pc	
Standard (G, M, C, S*)	\$5.60 /pc		D11PUR

Revere deco field



	4 1/4 x 4 1/4	8 pcs/sf	0.6 lbs/pc	
Standard (G, C, S*)	\$6.80 /pc		\$54.40 /sf	DF44REV
Alloy (A*)	\$8.50 /pc		\$68.00 /sf	DF44REVA

Santo Fico deco



	6 3/8 x 6 3/8	1.33 lbs/pc	
Standard (G, M, C, S*)	\$19.25 /pc		D66SAN
Jewel & Quartz (J*, Q)	\$22.15 /pc		D66SANJ
Heritage (H) <i>No Dove</i>	\$24.05 /pc		D66SANH

Sherman 2x6 Textured Field



	2 1/8 x 6 3/8	11 pcs/sf	0.4 lbs/pc	
Standard (G, M, C, S*)	\$3.85 /pc		\$42.35 /sf	FT26SHE
Alloy (A*)	\$4.80 /pc		\$52.80 /sf	FT26SHEA
Heritage (H) <i>No Dove</i>	\$4.80 /pc		\$52.80 /sf	FT26SHEH

Sherman 2x8 Textured Field

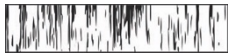

	2 1/8 x 8 5/8	8 pcs/sf	0.6 lbs/pc	
Standard (G, M, C, S*)	\$5.70 /pc		\$45.60 /sf	FT28SHE
Alloy (A*)	\$7.15 /pc		\$57.20 /sf	FT28SHEA
Heritage (H) <i>No Dove</i>	\$7.15 /pc		\$57.20 /sf	FT28SHEH

Sherman 3x8 Textured Field

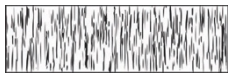

	3 1/8 x 8 5/8	5.25 pcs/sf	0.72 lbs/pc	
Standard (G, M, C, S*)	\$7.25 /pc		\$38.06 /sf	FT38SHE
Alloy (A*)	\$9.05 /pc		\$47.51 /sf	FT38SHEA
Heritage (H) <i>No Dove</i>	\$9.05 /pc		\$47.51 /sf	FT38SHEH

Sherman 4x10 Textured Field

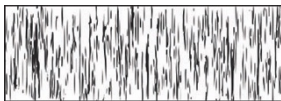

	4 1/4 x 10 3/8	3.25 pcs/sf	1.3 lbs/pc	
Standard (G, M, C, S*)	\$15.20 /pc		\$49.40 /sf	FT410SHE
Alloy (A*)	\$19.00 /pc		\$61.75 /sf	FT410SHEA
Heritage (H) <i>No Dove</i>	\$19.00 /pc		\$61.75 /sf	FT410SHEH

Spencer 2x6 Textured Field

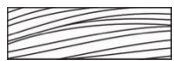

	2 1/8 x 6 3/8	11 pcs/sf	0.4 lbs/pc	
Standard (G, M, C, S*)	\$3.85 /pc		\$42.35 /sf	FT26SPE
Alloy (A*)	\$4.80 /pc		\$52.80 /sf	FT26SPEA
Heritage (H) <i>No Dove</i>	\$4.80 /pc		\$52.80 /sf	FT26SPEH

Spencer 2x8 Textured Field

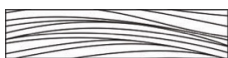

	2 1/8 x 8 5/8	8 pcs/sf	0.6 lbs/pc	
Standard (G, M, C, S*)	\$5.70 /pc		\$45.60 /sf	FT28SPE
Alloy (A*)	\$7.15 /pc		\$57.20 /sf	FT28SPEA
Heritage (H) <i>No Dove</i>	\$7.15 /pc		\$57.20 /sf	FT28SPEH

Glaze Codes:

(A) Alloy (C) Crackle (G) Gloss (H) Heritage (J) Jewel (M) Matte (P) Precocious (Q) Quartz (S) Sheer (W) Wash

* Alloys & Sheers are not recommended for pools or spas. Sheers are not recommended for floors.

All deco motifs sold by the piece. No minimums. Glazed edges available on some borders. Glazed edges available for \$12/edge upcharge.

	Spencer 3x8 Textured Field	3 1/8 x 8 5/8	5.25 pcs/sf	0.72 lbs/pc	
		Standard (G, M, C, S*)	\$7.25 /pc	\$38.06 /sf	FT38SPE
		Alloy (A*)	\$9.05 /pc	\$47.51 /sf	FT38SPEA
		Heritage (H) <i>No Dove</i>	\$9.05 /pc	\$47.51 /sf	FT38SPEH

	Spencer 4x10 Textured Field	4 1/4 x 10 3/8	3.25 pcs/sf	1.3 lbs/pc	
		Standard (G, M, C, S*)	\$15.20 /pc	\$49.40 /sf	FT410SPE
		Alloy (A*)	\$19.00 /pc	\$61.75 /sf	FT410SPEA
		Heritage (H) <i>No Dove</i>	\$19.00 /pc	\$61.75 /sf	FT410SPEH

	Splendor border	2 1/8 x 9 1/4		0.5 lbs/pc	
		Standard (G, M, C, S*)	\$17.35 /pc		B29SPL
		Jewel & Quartz (J, Q)	\$19.95 /pc		B29SPLJ

	Tamara deco field	4 1/4 x 4 1/4	8 pcs/sf	0.5 lbs/pc	
		Standard (G, M, C, S*)	\$6.80 /pc	\$54.40 /sf	DF44TAM
		Jewel & Quartz (J, Q)	\$7.82 /pc	\$62.56 /sf	DF44TAMJ
		Alloy (A*)	\$8.50 /pc	\$68.00 /sf	DF44TAMA

	Trust deco	3 5/8 x 7		0.53 lbs/pc	
		Standard (G, M, C, S*)	\$18.45 /pc		D37TRU
		Jewel (J) <i>No Quartz</i>	\$20.30 /pc		D37TRUJ
		Precocious (P)	\$23.05 /pc		D37TRUP
		Wash (W)	\$23.05 /pc		D37TRUW

	Umbria border	3 1/8 x 8 1/2		0.7 lbs/pc	
		Standard (G, M, C, S*)	\$18.15 /pc		B38UMB
		Jewel & Quartz (J, Q)	\$20.90 /pc		B38UMBJ
		Alloy (A*)	\$22.70 /pc		B38UMA
		Heritage (H) <i>No Dove</i>	\$22.70 /pc		B38UMH

	Verona deco	3 1/8 x 3 1/8		0.3 lbs/pc	
		Standard (G, M, C, S*)	\$9.35 /pc		D33VER
		Jewel & Quartz (J*, Q)	\$10.75 /pc		D33VERJ
		Alloy (A*) <i>Bronze Only</i>	\$43.75 /pc		D33VERA

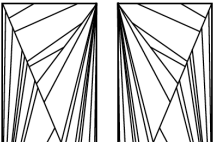
	Whitman deco field	4 1/4 x 10 3/8	3.23 pcs/sf	1.36 lbs/pc		
		Standard (G, M, C, S*)	Left	\$15.55 /pc	Pattern Price	DF410WHIL
		Standard (G, M, C, S*)	Right	\$15.55 /pc	\$50.23 /sf	DF410WHIR
		Alloy (A*)	Left	\$19.45 /pc	Pattern Price	DF410WHILA
		Alloy (A*)	Right	\$19.45 /pc	\$62.82 /sf	DF410WHIRA

	Wyndham deco field	4 1/4 x 4 1/4	8 pcs/sf	0.6 lbs/pc	
		Standard (G, M, C, S*)	\$6.80 /pc	\$54.40 /sf	DF44WYN
		Alloy (A*) <i>Bronze Only</i>	\$8.50 /pc	\$68.00 /sf	DF44WYNA
		Heritage (H) <i>No Dove</i>	\$8.50 /pc	\$68.00 /sf	DF44WYNH

Glaze Codes:

(A) Alloy (C) Crackle (G) Gloss (H) Heritage (J) Jewel (M) Matte (P) Precocious (Q) Quartz (S) Sheer (W) Wash

* Alloys & Sheers are not recommended for pools or spas. Sheers are not recommended for floors.

All deco motifs sold by the piece. No minimums. Glazed edges available on some borders. Glazed edges available for \$12/edge upcharge.

ENCORE CERAMICS
July 1, 2024 Wholesale Price List

Zamora deco field

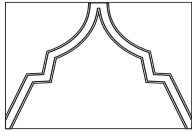

6 3/8 x 8 3/8	2.53 pcs/sf	1.55 lbs/pc	
Standard (G, M, C, S*)	\$18.70 /pc	\$47.31 /sf	DF68ZAM
Alloy (A*)	\$21.50 /pc	\$54.40 /sf	DF68ZAMA
Heritage (H) <i>No Dove</i>	\$23.40 /pc	\$59.20 /sf	DF68ZAMH

Glaze Codes:

(A) Alloy **(C)** Crackle **(G)** Gloss **(H)** Heritage **(J)** Jewel **(M)** Matte **(P)** Precocious **(Q)** Quartz **(S)** Sheer **(W)** Wash

* Alloys & Sheers are not recommended for pools or spas. Sheers are not recommended for floors.